

# SERVICE AT ITS BEST

## PROFESSIONAL COOLING SOLUTIONS FOR HOTELS AND RESTAURANTS

Whether it's a family-run Bed & Breakfast, a cruise liner or the world's first (and only) 7-star hotel, the hospitality industry trusts Dometic to deliver high-quality solutions for enhanced guest satisfaction. Today you can find millions of Dometic minibars, fridges and wine coolers

in hotels of all star categories across the world – something we are very proud of. The best products are now here for you to explore. Enjoy browsing and let us know what we can do for you.

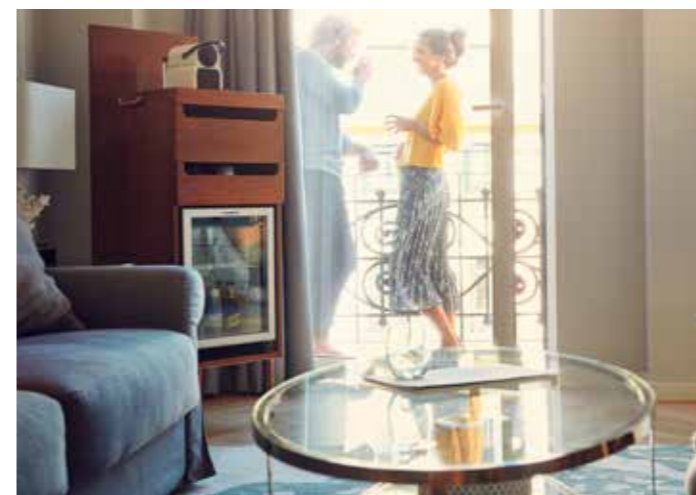

## REFRIGERATORS & MINIBARS

Choose from the world's largest range of refrigerators and minibars. Drawer minibars for convenient slide-out access. HiPro minibars for lowest energy consumption. HiPro Vision minibars with coloured transparent doors. Plus four well proven product lines with different benefits.

**PAGE 148 – 157**

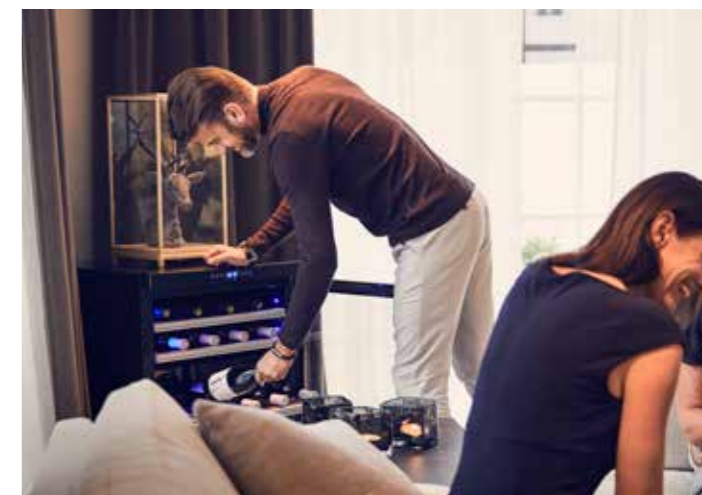

## WINE REFRIGERATORS

Well proven in bars, restaurants and hotels as well as in offices and private households: Dometic wine refrigerators meet the highest demands on quality and design. All models are supplied fully equipped – including shelves and all essential accessories.

**PAGE 158 – 163**



## MILK- & BEVERAGE COOLERS

Handy desktop coolers and elegant mini fridges for milk and other beverages. All with wear-free thermoelectric cooling technology and many practical details for convenient handling. Ideal for cafés, restaurants, offices and homes.

**PAGE 164 – 165**

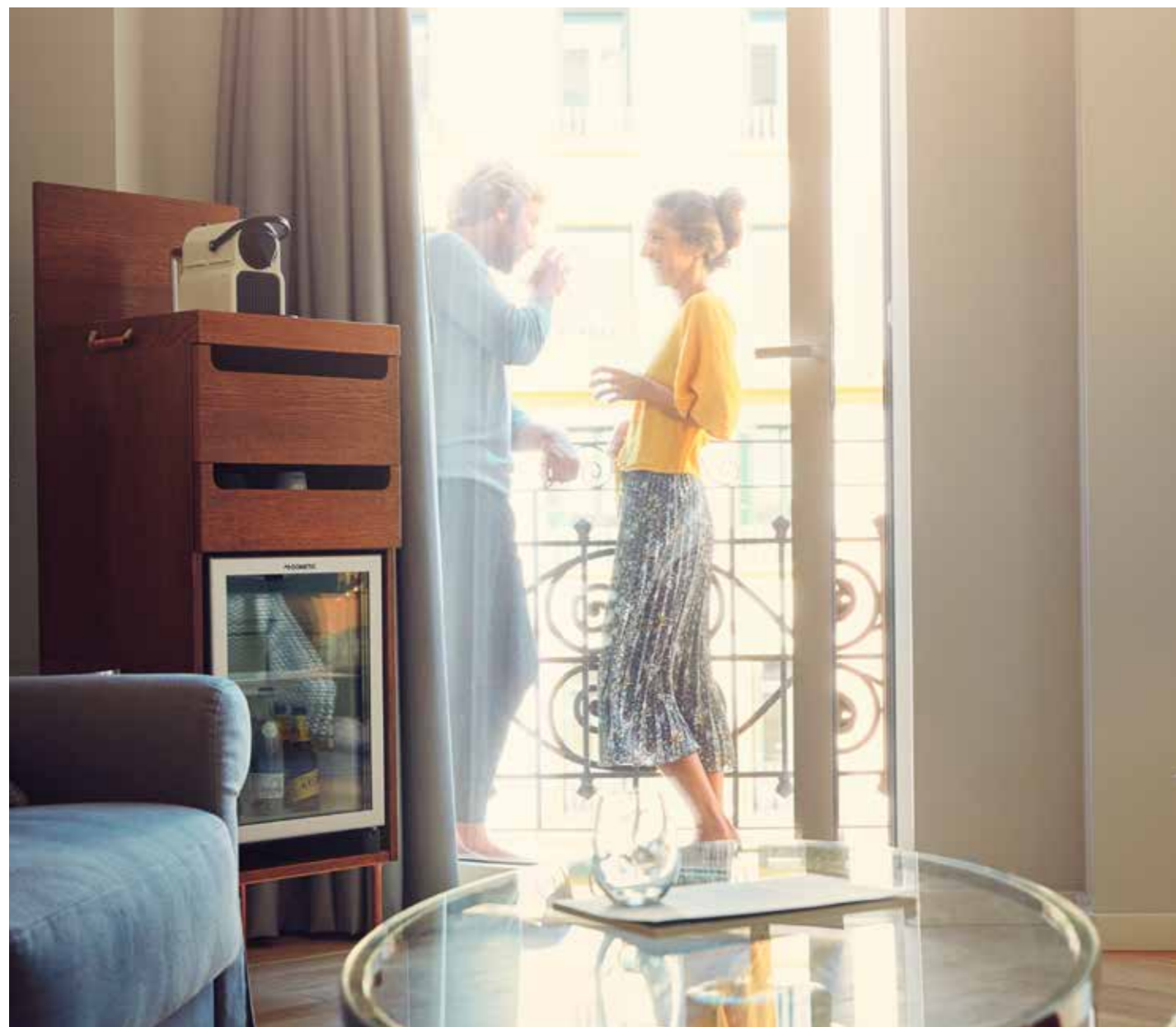

# DOMETIC MINIBARS





ALWAYS AT YOUR SERVICE

Dometic minibars never rest. They cater discreetly to the needs of your guests – at any time of the day or night. Fitted with state-of-the-art refrigeration technology, Dometic minibars are highly energy-efficient. This reduces your operational expenses as well as the impact on the environment. Most of our minibars are entirely silent and vibration-free, as they have no moving parts.

Besides functionality, design is another key factor to be considered when choosing the right minibar models for your guest rooms. Here again, our comprehensive range gives you many attractive options – from drawer minibars to nicely integrated solutions with customized door panels to beautiful freestanding model with a transparent glass door for enticing product presentation.

## DOMETIC MINIBARS DM 20 / DM 50

Thermoelectric drawer minibars

	DM 20 D/F	DM 50 D/F
DM 20 D		
		
DM 20 F		
		
DM 50 D		
		
DM 50 F		
		
	<b>Model class</b>	20 l
	<b>Storage volume</b>	15.8 l
	<b>Cabinet colours</b>	Anthracite
	<b>Dimensions</b>	
	<b>Built-in version (H x W x D)</b>	DM 20 D: 365 x 384 x 428 DM 20 F: 365 x 384 x 398
	<b>Can be built-in/integrated</b>	•
	<b>LED interior light</b>	•
	<b>Input rating</b>	52 W
	<b>Energy consumption</b>	0.20 kWh/24 h
	<b>Energy efficiency class</b>	A++
	<b>Noise level</b>	0 db(A)
	<b>Options</b>	• Lock
	<b>Product</b>	<b>Ref. No.</b>
	Dometic DM 20 D	9105330176
	Dometic DM 20 F	9105330178
	Dometic DM 50 D	9105330674
	Dometic DM 50 F	9105330670

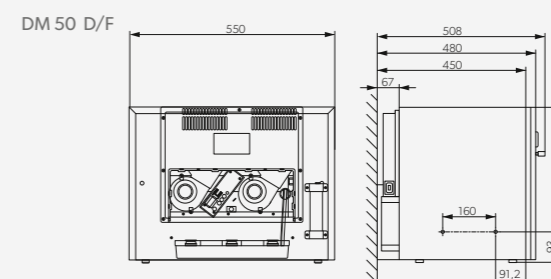
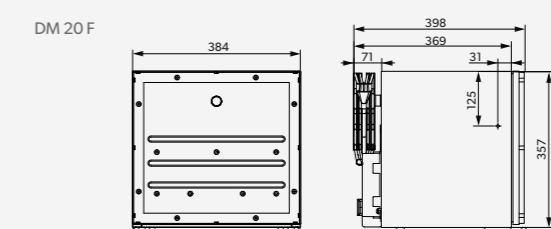
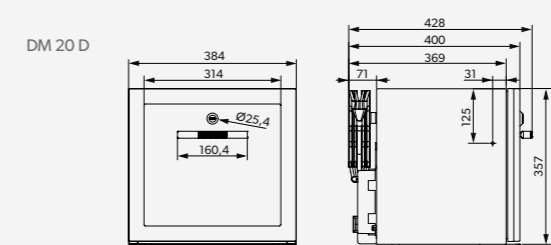



## DOMETIC MINIBARS HIPRO SERIES

Absorption minibars

	HIPRO 3000	HIPRO 4000	HIPRO 6000	HIPRO VISION
<b>Model class</b>	30 l	40 l	60 l	40 l
<b>Model versions</b>	Basic, Standard	Basic, Standard	Basic, Standard	Acrylic Glass Door with two shelves
<b>Storage volume</b>	26 l	34 l	48 l	34 l
<b>Cabinet colour</b>	Anthracite	Anthracite	Anthracite	Anthracite
<b>Dimensions built-in version (H x W x D)</b>	527 x 388 x 418 mm	559 x 405 x 452 mm	568 x 490 x 475 mm	559 x 405 x 465 mm
<b>Can be built-in/integrated</b>	•	•	•	•
<b>Variable sliding hinge</b>	•	•	•	–
<b>Variable door hinge</b>	•	•	•	•
<b>LED interior light</b>	•	•	•	•
<b>Input rating</b>	65 W	65 W	80 W	65 W
<b>Energy consumption</b>	0.57 kWh/24 h	0.65 kWh/24 h	0.70 kWh/24 h	0.74 kWh/24 h
<b>Noise level</b>	0 db(A)	0 db(A)	0 db(A)	0 db(A)
<b>Options</b>	<ul style="list-style-type: none"> <li>Lock</li> <li>Decorative panel</li> <li>LED door opening control display</li> <li>Temperatur setting by remote control</li> </ul>	<ul style="list-style-type: none"> <li>Lock</li> <li>Decorative panel</li> <li>LED door opening control display</li> <li>Temperatur setting by remote control</li> <li>Also available as stand-alone model*</li> </ul>	<ul style="list-style-type: none"> <li>Lock</li> <li>Decorative panel</li> <li>LED door opening control display</li> <li>Temperatur setting by remote control</li> </ul>	<ul style="list-style-type: none"> <li>Lock</li> <li>LED door opening control display</li> <li>Temperatur setting by remote control</li> <li>Also available as stand-alone model*</li> <li>Colour options: Grey, Orange, Red, Dark Blue</li> </ul>
<b>Product</b>				<b>Ref. No.</b>
Dometic HiPro 3000				9600026689
Dometic HiPro 4000				9600026693
Dometic HiPro 6000				9600026686
Dometic HiPro Vision				9600026703

	HiPro 3000	HiPro 4000	HiPro 6000
H	527	559	568
B	388	405	490
B1	124,5	133	165,5
T	418	452	474,5
T1	84	84	88,5
T2	296	330	348
R	9608	9608	19361

\*Available with rear wall cover and 42 mm feet (+20 mm depth).

## DOMETIC MINIBARS RH CLASSIC LINE

Absorption minibars

	RH 423 LDA	RH 439 LD / RH 449 LD	RH 548 LD	RH 569 LD
<b>Model class</b>	23 l	30/40 l	40 l	60 l
<b>Storage volume</b>	23 l	25/32 l	37 l	58 l
<b>Cabinet colour</b>	Anthracite	Anthracite	Anthracite	Anthracite
<b>Dimensions built-in version (H x W x D)</b>	435 x 422 x 384 mm	522 x 380 x 434 mm (RH 439 LD) 552 x 422 x 439 mm (RH 449 LD)	554 x 401 x 446 mm	560 x 486 x 484 mm
<b>Can be built-in/integrated</b>	•	•	•	•
<b>Sliding hinge</b>	•	•	•	•
<b>Variable door hinge</b>	•	•	•	•
<b>LED interior light</b>	•	•	•	•
<b>Input rating</b>	65 W	65 W	65 W	75 W
<b>Energy consumption</b>	0.70 kWh/24 h	0.65/0.70 kWh/24 h	0.75 kWh/24 h	0.76 kWh/24 h
<b>Noise level</b>	0 db(A)	0 db(A)	0 db(A)	0 db(A)
<b>Options</b>	<ul style="list-style-type: none"> <li>LED door opening control</li> <li>Temperature setting by remote control</li> <li>Door handle</li> <li>Also available as stand-alone model (FS Version)</li> </ul>	<ul style="list-style-type: none"> <li>LED door opening control</li> <li>Temperature setting by remote control</li> <li>Door handle</li> <li>Also available as stand-alone model (FS version)</li> </ul>	<ul style="list-style-type: none"> <li>LED door opening control</li> <li>Temperature setting by remote control</li> </ul>	<ul style="list-style-type: none"> <li>LED door opening control</li> <li>Temperature setting by remote control</li> </ul>
<b>Product</b>				<b>Ref. No.</b>
Dometic RH 423 LDA				9600026745
Dometic RH 439 LD				9600026742
Dometic RH 449 LD				9600026772
Dometic RH 548 LD				9600026800
Dometic RH 569 LD				9600026802

  

Model	H	B	T	T1	T2	R
RH 423 LD	463	422	350	84	296	9608
RH 439 LD	522	380	434	84	330	9608
RH 449 LD	554	401	446	84	348	19361
RH 548 LDBI	554	401	446	84	348	19361
RH 569 LDBI	560	486	484	84	348	19361

\*Depth with door closed

**DOMETIC RH418NTE**

Thermoelectric minibars

	<b>Model class</b>	20 l
	<b>Storage volume</b>	18 l
	<b>Cabinet colour</b>	Anthracite
	<b>Model versions</b>	Solid door model
	<b>Dimensions FS (H x W x D)</b>	435 x 422 x 350
	<b>Energy consumption</b>	0,222 kWh/24 h
	<b>Energy class</b>	A++
	<b>Noise level</b>	0 db(A)
	<b>Options</b>	<ul style="list-style-type: none"> <li>Sliding hinge</li> <li>Lock</li> <li>LED door opening control</li> <li>Temperature setting by remote control</li> </ul>
	<b>Product</b>	<b>Ref. No.</b>
Dometic RH418NTE, right hinge	9105204660	
Dometic RH418NTE, left hinge	9600026474	

**DOMETIC RH418NTEG**

Thermoelectric minibars

	<b>Model class</b>	20 l
	<b>Storage volume</b>	18 l
	<b>Cabinet colour</b>	Anthracite
	<b>Model versions</b>	With three-layer glass door
	<b>Dimensions FS (H x W x D)</b>	435 x 422 x 350
	<b>Energy consumption</b>	0,285 kWh/24 h
	<b>Energy class</b>	A+
	<b>Noise level</b>	0 db(A)
	<b>Options</b>	<ul style="list-style-type: none"> <li>Handle</li> <li>Lock</li> <li>LED door opening control</li> <li>Temperature setting by remote control</li> </ul>
	<b>Product</b>	<b>Ref. No.</b>
Dometic RH418NTEG, right hinge	9105204659	
Dometic RH418NTEG, left hinge	9600026475	

**DOMETIC MINIBARS RH CLASSIC LINE GLASS DOOR MODELS**

Absorption minibars

	RH 429 LDAG	RH 439 LDAG	RH 449 LDAG	
RH 429 LDAG 	<b>Model class</b>	20 l	30 l	40 l
	<b>Storage volume</b>	18 l	26 l	33 l
	<b>Cabinet colour</b>	Anthracite	Anthracite	Anthracite
	<b>Dimensions Built-in version (H x W x D)</b>	435 x 422 x 384 mm	522 x 380 x 434 mm	552 x 422 x 439 mm
	<b>Can be built-in/integrated</b>	•	•	•
	<b>Variable door hinge</b>	•	•	•
	<b>LED interior light</b>	•	•	•
	<b>Input rating</b>	75 W	75 W	75 W
	<b>Energy consumption</b>	0.74 kWh/24 h	0.75 kWh/24 h	0.75 kWh/24 h
	<b>Noise level</b>	0 db(A)	0 db(A)	0 db(A)
	<b>Options</b>	<ul style="list-style-type: none"> <li>LED door opening control</li> <li>Temperature setting by remote control</li> <li>Also available as stand-alone model (FS version)</li> <li>Door handle</li> </ul>	<ul style="list-style-type: none"> <li>LED door opening control</li> <li>Temperature setting by remote control</li> <li>Also available as stand-alone model (FS version)</li> <li>Door handle</li> </ul>	<ul style="list-style-type: none"> <li>LED door opening control</li> <li>Temperature setting by remote control</li> <li>Also available as stand-alone model (FS version)</li> <li>Door handle</li> </ul>
	<b>Product</b>			<b>Ref. No.</b>
	Dometic RH 429 LDAG			9600026825
	Dometic RH 439 LDAG			9600026839
	Dometic RH 449 LDAG			9600026852

RH 439 LDAG



RH 449 LDAG

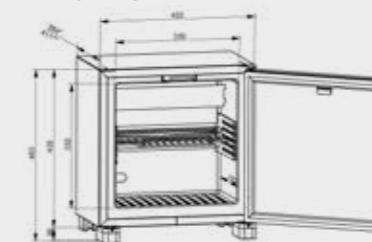

RH 429 LDAG

\* Depth by closed door  
\*\* Depth by closed door with handle

RH 439 LDAG

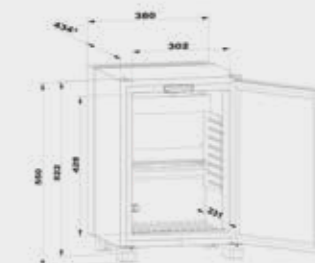

\* DEPTH BY CLOSED DOOR

RH 449 LDAG

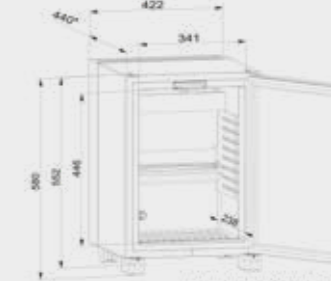

\* DEPTH BY CLOSED DOOR

## DOMETIC MINIBARS ECO LINE

Thermoelectric and absorption minibars

	RH 430 NTE	RH 440 NTE	RH 430 LG	RH 440 LG
RH 430 NTE				
<b>Model class</b>	30 l	40 l	30 l	40 l
<b>Storage volume</b>	25 l	34 l	27 l	37 l
<b>System</b>	Thermoelectric	Thermoelectric	Absorption	Absorption
<b>Cabinet colours</b>	Anthracite	Anthracite	Anthracite	Anthracite
<b>Dimensions (H x W x D)</b>	522 x 384 x 395 mm	554 x 401 x 425 mm	522 x 384 x 422 mm	554 x 401 x 456 mm
<b>Sliding hinge</b>	•	•	-	-
<b>Can be built-in/integrated</b>	•	•	•	•
<b>Variable door hinge</b>	•	•	•	•
<b>LED interior light</b>	•	•	•	•
<b>Input rating</b>	55 W	55 W	65 W	65 W
<b>Energy consumption</b>	0.29 kWh/24 h	0.29 kWh/24 h	1.0 kWh/24 h	1.0 kWh/24 h
<b>Energy efficiency class</b>	A+	A+	-	-
<b>Noise level</b>	0 db(A)	0 db(A)	-	-
<b>Product</b>				<b>Ref. No.</b>
Dometic RH 430 NTE				9105305825
Dometic RH 440 NTE				9105305827
Dometic RH 430 LG				9105305983
Dometic RH 440 LG				9105305987



RH 440 NTE



RH 430 LG



RH 440 LG



Dometic RH 430 NTE

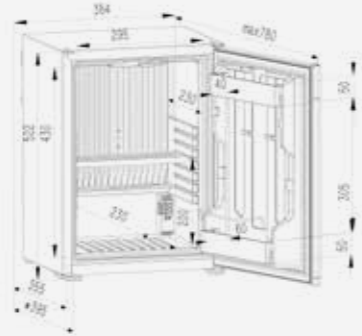

RH 430 LG

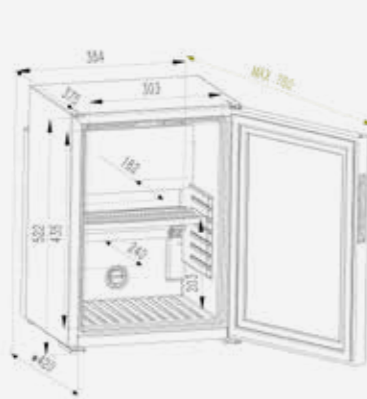

Dometic RH 440 NTE

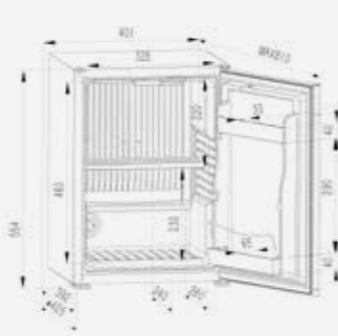

RH 440 LG

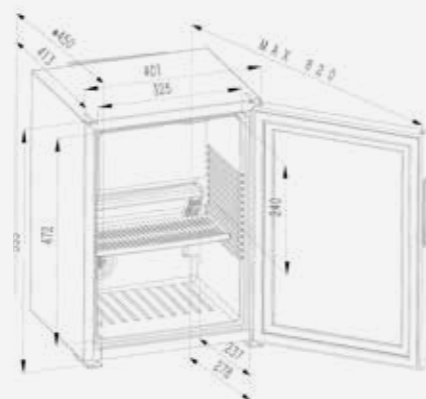

\*Depth with door closed

## DOMETIC MINIBARS BASIC LINE

Absorption minibars

	RH 131 LD	RH 141 LD
RH 131 LD		
<b>Model class</b>	30 l	40 l
<b>Storage volume</b>	28 l	38 l
<b>Cabinet colour</b>	Black	Black
<b>Dimensions built-in version (H x W x D)</b>	524 x 380 x 445 mm	554 x 422 x 451 mm
<b>Can be built-in/integrated</b>	•	•
<b>Sliding hinge</b>	•	•
<b>Variable door hinge</b>	•	•
<b>Input rating</b>	65 W	65 W
<b>Energy consumption</b>	0.73 kWh/24 h	0.75 kWh/24 h
<b>Noise level</b>	0 db(A)	0 db(A)
<b>Options</b>	<ul style="list-style-type: none"> <li>LED interior light (RH 131 LDFS/LDBI)</li> <li>Lock</li> </ul>	<ul style="list-style-type: none"> <li>LED interior light (RH 141 LDFS/LDBI)</li> <li>Lock</li> </ul>
<b>Product</b>	<b>Ref. No.</b>	
Dometic RH 131 LD	9600026863	
Dometic RH 141 LD	9600026862	



RH 141 LD



RH 131 LD

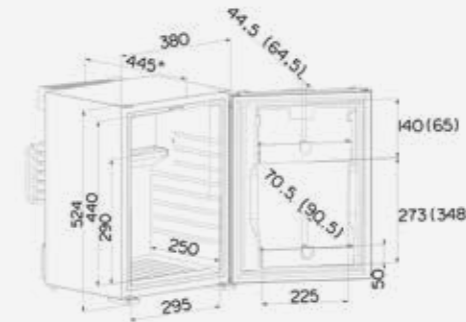

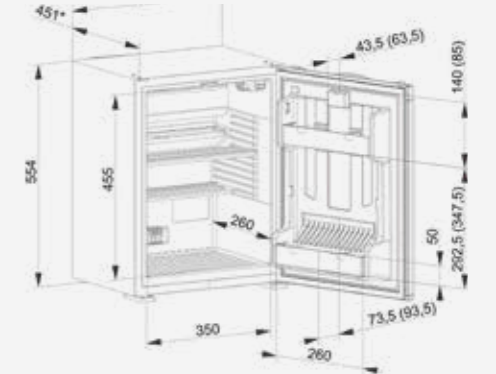

RH 141 LD



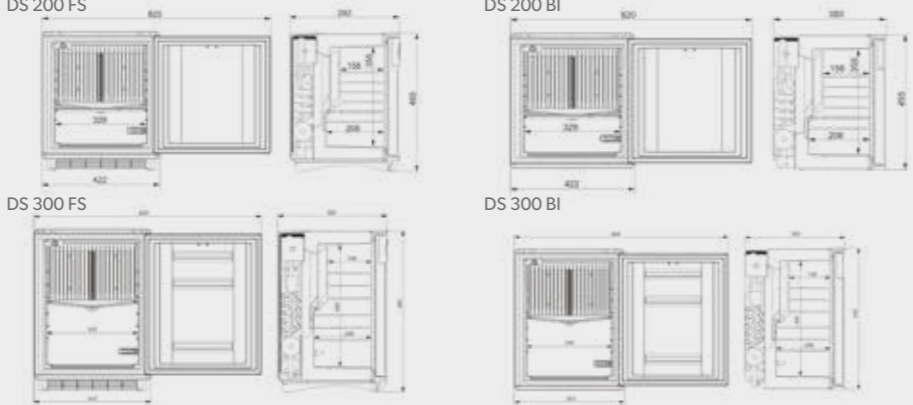

## DOMETIC MINICOOL / FOOD LINE

Absorption minibars

	DS 200 FS/BI	DS 300 FS/BI	
 DS 200 FS/BI   DS 300 FS/BI	<b>Model class</b>	20 l	30 l
	<b>Storage volume</b>	21 l	27 l
	<b>Cabinet colour</b>	Black or white	Black or white
	<b>Dimensions FS*</b> (H x W x D)	495 x 422 x 393 mm	580 x 422 x 393 mm
	<b>Dimensions built-in version**</b> (H x W x D)	455 x 422 x 383 mm	540 x 422 x 383 mm
	<b>Can be built-in/integrated</b>	•	•
	<b>Variable door hinge</b>	•	•
	<b>LED interior light</b>	•	•
	<b>Input rating</b>	65 W	65 W
	<b>Energy consumption</b>	0.74 kWh/24 h	0.76 kWh/24 h
	<b>Noise level</b>	0 db(A)	0 db(A)
	<b>Options</b>	<ul style="list-style-type: none"> <li>• Sliding hinge</li> <li>• Lock</li> <li>• Wheels</li> </ul>	<ul style="list-style-type: none"> <li>• Sliding hinge</li> <li>• Lock</li> <li>• Wheels</li> </ul>
	<b>Product</b>	<b>Ref. No.</b>	
Dometic DS 200 FS	9600026779		
Dometic DS 200 BI	9600026781		
Dometic DS 300 FS	9600026782		
Dometic DS 300 BI	9600026784		
*FS version: with foot frame, door decor panel and back cover, ** BI version: for fully-integrated installation (with sliding hinge, without exterior ABS plastic cabinet, door panel and foot frame)			
			

## DOMETIC MINICOOL / FOOD LINE

Absorption minibars

	DS 400 FS/BI	DS 600 FS/BI	
 DS 400 FS/BI   DS 600 FS/BI	<b>Model class</b>	40 l	60 l
	<b>Storage volume</b>	32 l	43 l
	<b>Cabinet colour</b>	Black or white	Black or white
	<b>Dimensions FS*</b> (H x W x D)	580 x 422 x 450 mm	592 x 486 x 494 mm
	<b>Dimensions built-in version**</b> (H x W x D)	540 x 422 x 440 mm	552 x 486 x 484 mm
	<b>Can be built-in/integrated</b>	•	•
	<b>Variable door hinge</b>	•	•
	<b>LED interior light</b>	•	•
	<b>Input rating</b>	65 W	85 W
	<b>Energy consumption</b>	0.76 kWh/24 h	0.77 kWh/24 h
	<b>Noise level</b>	0 db(A)	0 db(A)
	<b>Options</b>	<ul style="list-style-type: none"> <li>• Sliding hinge</li> <li>• Lock</li> <li>• Wheels</li> </ul>	<ul style="list-style-type: none"> <li>• Sliding hinge</li> <li>• Lock</li> <li>• Wheels</li> </ul>
	<b>Product</b>	<b>Ref. No.</b>	
Dometic DS 400 FS	9600026664		
Dometic DS 400 BI	9600026671		
Dometic DS 600 FS	9600026678		
Dometic DS 600 BI	9600026683		
*FS version: with foot frame, door decor panel and back cover, ** BI version: for fully-integrated installation (with sliding hinge, without exterior ABS plastic cabinet, door panel and foot frame)			
			





# WINE REFRIGERATORS FROM DOMETIC

## SOLUTIONS FOR WINE STORAGE AND SERVICE

Wine connoisseurs, gourmets and restaurateurs all agree: For a wine to reveal its bouquet optimally, both storage conditions and the serving temperature must be right. This has been our job for decades to make sure this is right. In our role as specialist for mobile refrigeration and climate control solutions, we have built a

comprehensive product range for keeping wines at their optimum temperature. The attractive MaCave wine refrigerators from Dometic have proven their worth in bars, restaurants and hotels as well as in offices and private households. They meet the highest demands on quality and design and are available in numerous sizes and versions.

## DOMETIC MACAVE D52

4.31

Compressor wine cellar with stainless steel glass door, 52 bottles

	<b>Cooling system</b>	Compressor technology
	<b>Voltage</b>	220 – 240 V AC
	<b>Refrigerant</b>	R600a, Refrigerant quantity: 39 g, CO <sub>2</sub> equivalent: 0.000117 t, Global warming potential (GWP): 3
	<b>Temperature zones</b>	1
	<b>Temperature range</b>	+5 to +22 °C in standard operation, +2 to +6 °C in beverage mode
	<b>Counter shelves</b>	4 counter shelves of which 3 are made of metal
	<b>Colour</b>	Silver / black
	<b>Power Input</b>	100 watts
	<b>Material</b>	Stainless steel frame, glass door, housing: sheet steel
	<b>Dimensions (W x H x D)</b>	595 x 863 x 580 mm (620 with handle)
<b>Quality features</b>	Automatic defrost, 2-layer UV resistance glass door, active carbon filter for better wine climate, LED Interior light, automatic keyboard locking, silent mode, temperature control and warning system	
<b>Scope of delivery</b>	Operating manual, water tank, 2 keys	
<b>Product</b>		<b>Ref. No.</b>
Dometic MaCave D52		9600001934
<b>/ Optional extras</b>		
Carbon filter		9103500156

## DOMETIC MACAVE S17G

4.31

Compressor wine cellar with glass door, 17 bottles

	<b>Cooling system</b>	Compressor technology
	<b>Voltage</b>	220 – 240 V AC
	<b>Refrigerant</b>	R600a, Refrigerant quantity: 18 g, CO <sub>2</sub> equivalent: 0.000054 t, Global warming potential (GWP): 3
	<b>Temperature zones</b>	2
	<b>Temperature range</b>	+5 °C to +22 °C,
	<b>Counter shelves</b>	6 counter shelves of which 5 are made of wood
	<b>Colour</b>	Silver / black
	<b>Current consumption</b>	138 kWh / year
	<b>Material</b>	Stainless steel glass door, housing: coated sheet steel
	<b>Dimensions (W x H x D)</b>	295 x 820 x 570 mm (615 with handle)
<b>Quality features</b>	Removable service compartments, active carbon filter for neutralising foreign odours; lockable door, LED interior lighting which can be switched on/off	
<b>Scope of delivery</b>	1 x operating manual, 1 x water tank, 2 x keys, 7 x labels	
<b>Product</b>		<b>Ref. No.</b>
Dometic MaCave S17G		9103540066
<b>/ Optional extras</b>		
Storage rack floors		9103540117
Carbon filter		9103500156
Label set (20 pieces)		9103540116

**DOMETIC MACAVE S46G**

4.31

Compressor wine cellar with glass door, 46 bottles

	<b>Cooling system</b>	Compressor technology
	<b>Voltage</b>	220 – 240 V AC
	<b>Refrigerant</b>	R600a, Refrigerant quantity: 28 g, CO <sub>2</sub> equivalent: 0.000084 t, Global warming potential (GWP): 3
	<b>Temperature zones</b>	2
	<b>Temperature range</b>	+5 °C to +22 °C,
	<b>Counter shelves</b>	6 counter shelves of which 5 are made of wood
	<b>Colour</b>	Silver / black
	<b>Current consumption</b>	145 kWh / year
	<b>Material</b>	Stainless steel glass door, housing: coated sheet steel
	<b>Dimensions (W x H x D)</b>	595 x 820 x 570 mm (615 with handle)
<b>Quality features</b>	Removable service compartments, active carbon filter for neutralising foreign odours; lockable door, LED interior lighting which can be switched on/off	
<b>Scope of delivery</b>	1 x operating manual, 1 x water tank, 2 x keys, 7 x labels	
<b>Product</b>		<b>Ref. No.</b>
Dometic MaCave S46G		9103540064
<b>/ Optional extras</b>		
Storage rack floors		9103540119
Carbon filter		9103500156
Label set (20 pieces)		9103540116

**DOMETIC MACAVE S16FG**

4.31

Compressor wine cellar, built-in or freestanding

	<b>Cooling system</b>	Compressor technology
	<b>Voltage</b>	220 – 240 V AC / 50 Hz
	<b>Refrigerant</b>	R600a, Refrigerant quantity: 47 g, CO <sub>2</sub> equivalent: 0.000141 t, Global warming potential (GWP): 3
	<b>Temperature zones</b>	2
	<b>Temperature range</b>	+5 °C to +22 °C (standard mode) / +2 °C to +6 °C (beverage mode)
	<b>Storage compartments</b>	6 compartments, including 5 wooden slide-out shelves with metal front
	<b>Bottle capacity</b>	16 (standard configuration)
	<b>Colour</b>	Black
	<b>Material</b>	Glass door, coated sheet steel housing
	<b>Dimensions (W x H x D)</b>	295 x 820 x 575 mm (620 with handle)
<b>Quality features</b>	Two separate temperature zones, top zone programmable for beverage mode, frameless glass door, slide-out compartments for convenient access, white LED interior light, digital touchpad control with LED display	
<b>Scope of delivery</b>	Operating manual, water tank, 2 keys, 7 shelf labels	
<b>Product</b>		<b>Ref. No.</b>
Dometic MaCave S16FG		9600001708
<b>/ Optional extras</b>		
Carbon filter		9103540115
Label-Set (20 pcs.)		9103540116

**DOMETIC MACAVE S118G**

4.31

Compressor wine cellar with glass door, 118 bottles

	<b>Cooling system</b>	Compressor technology
	<b>Voltage</b>	220 – 240 V AC
	<b>Refrigerant</b>	R600a, Refrigerant quantity: 47 g, CO <sub>2</sub> equivalent: 0.000141 t, Global warming potential (GWP): 3
	<b>Temperature zones</b>	2
	<b>Temperature range</b>	+5 °C to +22 °C,
	<b>Counter shelves</b>	12 counter shelves: 10 removable wooden shelves, 1 service compartment
	<b>Colour</b>	Silver / black
	<b>Current consumption</b>	225 kWh / year
	<b>Material</b>	Stainless steel glass door, housing: coated sheet steel
	<b>Dimensions (W x H x D)</b>	595 x 1810 x 570 mm (615 with handle)
<b>Quality features</b>	Removable service compartments, active carbon filter for neutralising foreign odours; lockable door, LED interior lighting which can be switched on/off	
<b>Scope of delivery</b>	1 x operating manual, 1 x water tank, 2 x keys, 14 x labels	
<b>Product</b>		<b>Ref. No.</b>
Dometic MaCave S118G		9103540060
<b>/ Optional extras</b>		
Storage rack floors		9103540117
Carbon filter		9103500156
Label set (20 pieces)		9103540116
Service shelf		9103540068
Display shelf		9103540121

**DOMETIC MACAVE S117FG**

4.31

Compressor wine cellar for built-in or freestanding

	<b>Cooling system</b>	Compressor technology
	<b>Voltage</b>	220 – 240 V AC
	<b>Refrigerant</b>	R600a, Refrigerant quantity: 50 g, CO <sub>2</sub> equivalent: 0.00015 t, Global warming potential (GWP): 3
	<b>Temperature zones</b>	2
	<b>Temperature range</b>	+5 °C to +22 °C (standard mode) / +2 °C to +6 °C (beverage mode)
	<b>Storage compartments</b>	12 compartments, including 10 wooden slide-out shelves with metal front and 1 slide-out service compartment
	<b>Bottle capacity</b>	117 (standard configuration)
	<b>Colour</b>	Black
	<b>Storage volume</b>	335 litres
	<b>Energy efficiency class</b>	B (rated to climate class ST at 16 °C to 38 °C ambient temperature)
<b>Material</b>	Glass door, coated sheet steel housing	
<b>Dimensions (W x H x D)</b>	595 x 1768 x 575 mm (620 with handle)	
<b>Quality features</b>	Two separate temperature zones, top zone programmable for beverage mode, frameless glass door, slide-out shelves and slide-out service compartment, white LED interior light, digital touchpad control with LED display	
<b>Scope of delivery</b>	Operating manual, water tank, 2 keys, 7 shelf labels	
<b>Product</b>		<b>Ref. No.</b>
Dometic MaCave S117FG		9600001933
<b>/ Optional extras</b>		
Carbon filter		9103540115
Label set (20 pieces)		9103540116
Display shelf		9103540121



# DOMETIC MACAVE ACCESSORIES

Dometic MaCave wine refrigerators are supplied fully equipped with shelves and all essential accessories. Even so, you may want to add an extra shelf or service rack, replace a filter, or buy a fresh set of labels to identify your wines. Here are three of our most frequently ordered accessories.



## DOMETIC MACAVE PRESENTATION SHELF

For S46G / S118G / S117FG

- For attractive presentation of the wine offer
- Can be attached to the sliding shelves

Ref. No. 9103540121



## DOMETIC MACAVE SET OF LABELS

Practical little helpers

- Simply attach to the shelves to identify your wines
- Set of 20 black labels

Ref. No. 9103540116



## DOMETIC MACAVE CARBON FILTERS

Carbon filter

- For compressor wine refrigerators
- Create an optimal air quality
- Easy to replace

For S16FG, S117G  
Ref. No. 9103540115  
For D52, S17G, S46G, S118G  
Ref. No. 9103500156

## INSTALLATION FIGURES

### MACAVE S16G / S17G

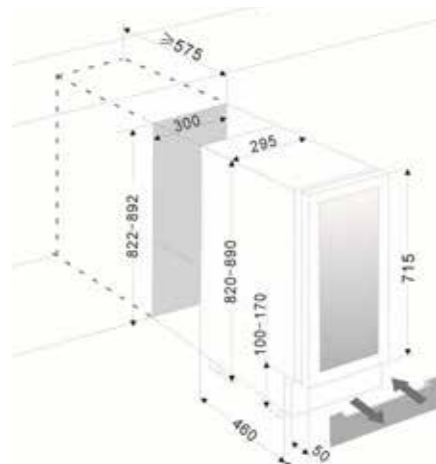

### MACAVE S46G

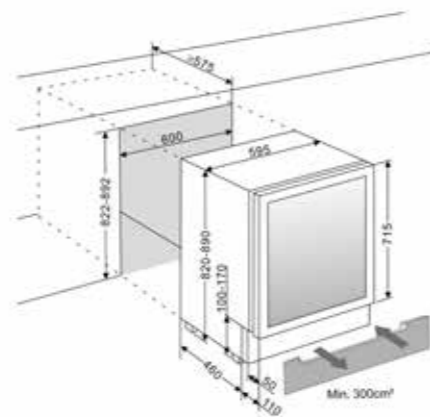

## CONFIGURATION GUIDE FOR SPACE-SAVING WINE STORAGE

### MACAVE S16FG

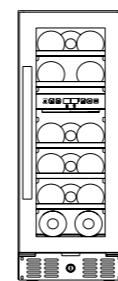

Standard configuration:  
16 bottles

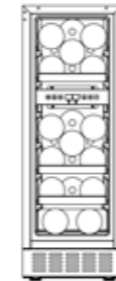

Max. filling:  
22 bottles

### MACAVE D52

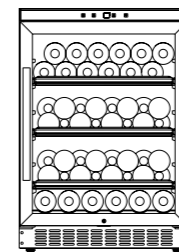

Standard configuration:  
52 bottles

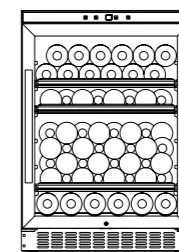

Max. filling:  
59 bottles

### MACAVE S17G

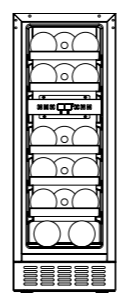

Standard configuration:  
17 bottles

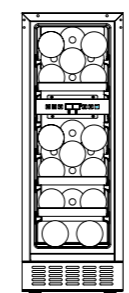

Max. filling:  
23 bottles

### MACAVE S46G

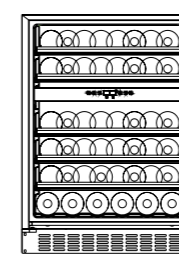

Standard configuration:  
46 bottles

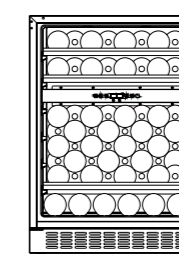

Max. filling:  
62 bottles

### MACAVE S117FG

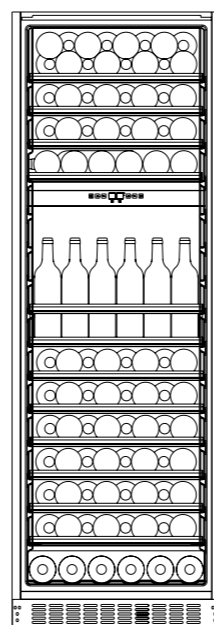

Standard configuration:  
117 bottles

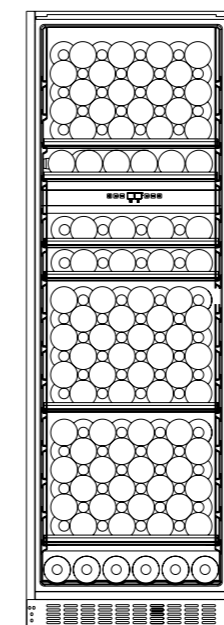

Max. filling: 165 bottles

### MACAVE S118G



Standard configuration:  
118 bottles

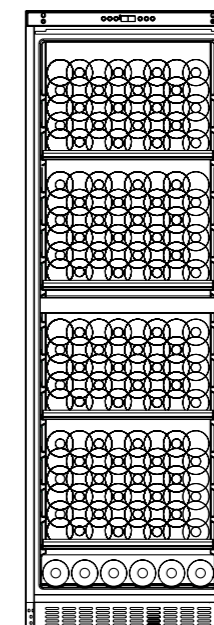

Max. filling: 182 bottles

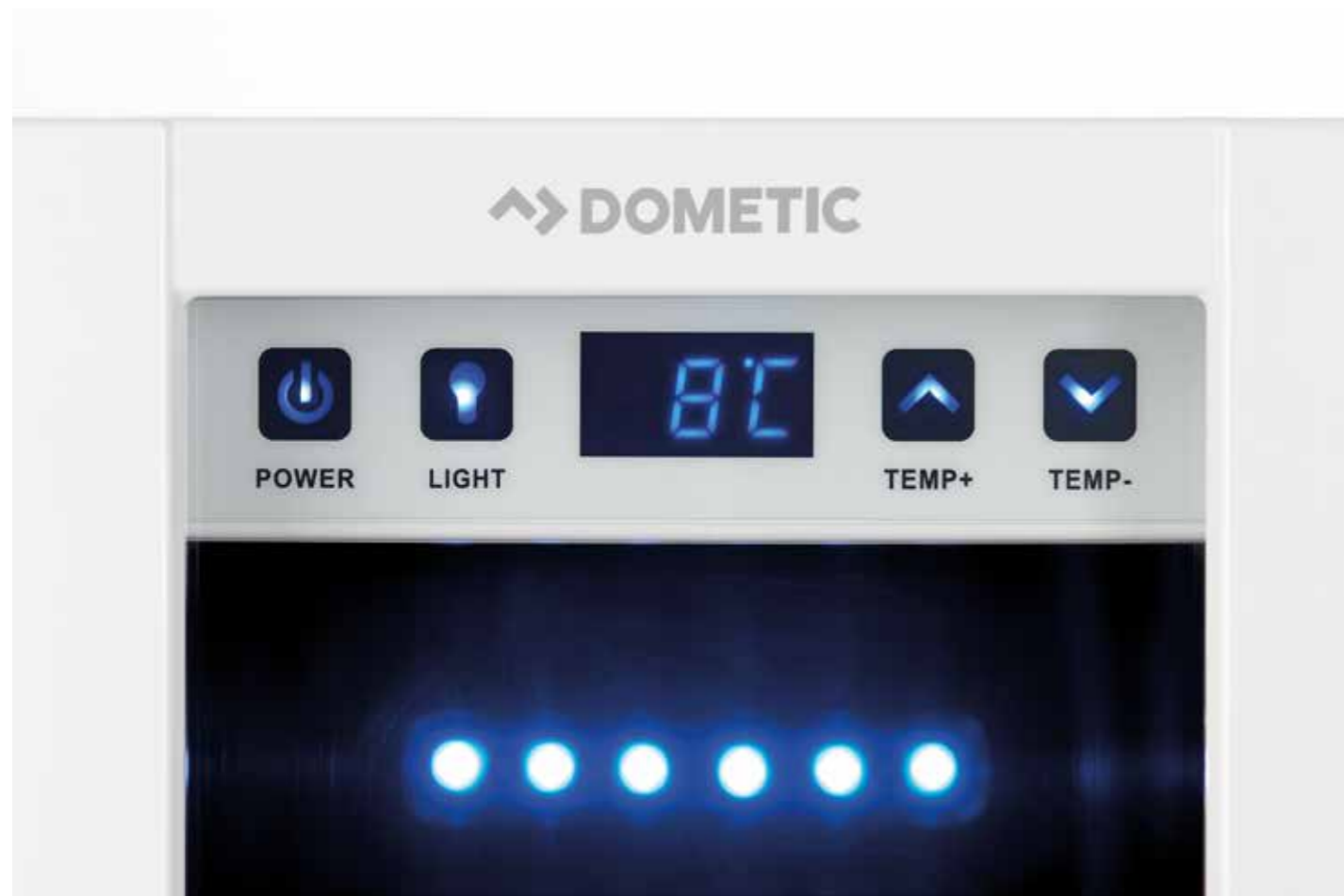

## SPACE-SAVING COOLING SOLUTIONS FOR MILK AND MORE

Cappuccino, café latte, latte macchiato or a simple espresso – the fully-automated coffee machine gives customers what they ask for. Practical equipment for keeping milk fresh is available from cooling specialist Dometic. The Dometic MyFridge products offer space-saving cooling solutions which were especially developed for cafés, restaurants and bistros. With the compact models MyFridge MF 05M

/ MF 1M, the milk is filled in dishwasher-safe glasses and then cooled down in the device. In the MyFridge MF 5M mini-fridge, it is drawn directly from the bottle or tetrapack. We recommend the Dometic DW 6 as an elegant bar refrigerator for fizzy water and soft drinks.

### DOMETIC MYFRIDGE MF 05M / MF 1M / MF 5

Milk cooler for automated coffee machines

3.20

	MF 05M	MF 1M	MF 5M
 MF 05M	<b>Gross capacity</b> 0.5 litres	1.0 litres	5 litres
 MF 1M	<b>Voltage</b> 100 – 240 V AC with power supply unit		230 V AC with integrated power adapter
 MF 5M	<b>Power consumption</b> Max. 20 watts		Max. 33 watts
	<b>Temperature range</b> Cooling down to 22 °C below ambient temperature, temperature limit at +1 °C		In cooling mode: up to 20 °C below the ambient temperature, temperature limit at +1 °C. In heating mode: temperature limit at +65 °C
	<b>Insulation</b> PU full foam insulation		
	<b>System</b> Thermoelectrics, powerful fan for continuous operation		
	<b>Material</b> ABS		
	<b>Colour</b> Silver/black		Silver
	<b>Weight</b> 0.9 kg	1.7 kg	3.3 kg
	<b>Dimensions (W x H x D)</b> 110 x 180 x 145 mm	150 x 215 x 190 mm	190 x 313 x 281 mm
	<b>Quality features</b> 0.5 litre milk glass, 20 cm milk hose and power supply unit	1.0 litre milk glass, 20 cm milk hose and power supply unit	Internal lighting, for up to two 1 litre milk pouches, lockable openings for milk hose, both sides; grid divider, 40 cm milk hose
	<b>Test marks</b> TÜV/GS, E-certified (Automotive EMC Directive)		
	<b>Product</b>	<b>Ref. No.</b>	
	Dometic MyFridge MF 05M	960000596	
	Dometic MyFridge MF 1M	960000597	
	Dometic MyFridge MF 5M	960000598	
	<b>/ Optional extras (MF 5M)</b>		
	Connection cable	960006608	
	Cap outer, chrome	40-126-03ABNNA	
	Cap inner, white	40-126-02AB9001	

### DOMETIC DW 6

Mini fridge, 20 litres

3.20

	<b>Gross capacity</b> 20 litres
	<b>Voltage</b> 12 V DC and 220 – 240 V AC
	<b>Power consumption</b> 36 W at 12 V DC, 43 W at 230 V AC
	<b>Energy class</b> A
	<b>Temperature range</b> +5 °C to +20 °C, cooling performance up to 16 °C below ambient temperature
	<b>Insulation</b> Polyurethane
	<b>System</b> Thermoelectrics
	<b>Material</b> ABS
	<b>Colour</b> White
	<b>Weight</b> 7.6 kg
	<b>Dimensions (W x H x D)</b> 266 x 415 x 515 mm
	<b>Quality features</b> Electronic thermostat with digital temperature display, continuous temperature selection, transparent door, safe magnetic lock, 3 shelves, interior lighting can be switched on/off, drip tray for condensation water
	<b>Test marks</b> TÜV/GS, E-certified (Automotive EMC Directive)
	<b>Product</b>
	<b>Ref. No.</b>
	Dometic DW 6
	9105330356



# REFRIGERATORS FOR HEALTH AND CARE FACILITIES

WELL PROVEN FOR DECADES – ALL OVER THE WORLD

Dometic is a leading manufacturer of cooling appliances for special applications – with decades of experience in the healthcare sector. Our reference list includes hospitals, retirement and nursing homes, doctor's surgeries, pharmacies and laboratories.

All products for the healthcare sector are manufactured to stringent quality and environmental standards in Dometic's own, certified factories. Our sales and service network spans almost 100 countries and provides personal support to customers and planners on every continent.

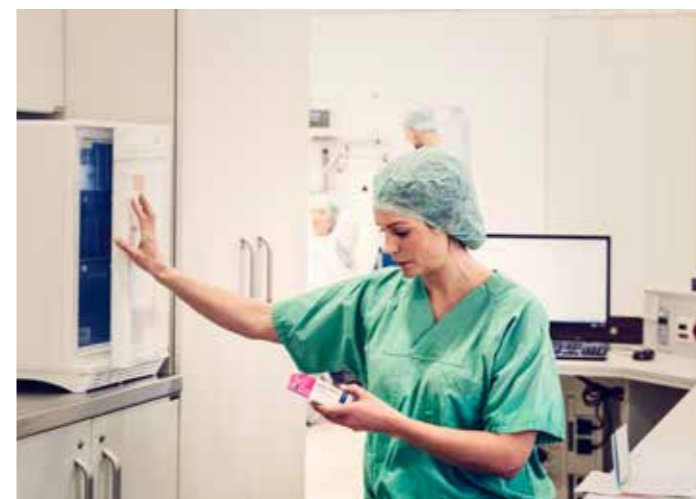

## SILENT ABSORPTION REFRIGERATORS

Well proven for decades, DS series medical refrigerators are ideal for safe storage of insulin and other heat-sensitive pharmaceuticals at a temperature between 2 °C and 8 °C. With external digital thermometer and drawers for well-organised storage.

PAGE 168 – 169



## POWERFUL, ENERGY- EFFICIENT COMPRESSOR REFRIGERATORS

HC series medical refrigerators are especially powerful and energy-saving. High-quality, roller based metal drawers with 3/4 extension allow for convenient handling, the thermometer is integrated in the door. DIN-certified models are also available.

PAGE 170 – 171



## CABINETS

Cooling or heating with  $\pm 1$  °C accuracy: Dometic's innovative generation of refrigerator and warmer cabinets was specifically designed for use in emergency vehicles. The interior temperature is limited at +5 °C or, respectively, +37 °C ( $\pm 1$  °C). This, combined with well thought-out details, qualifies the cabinets for other applications, too.

PAGE 172 – 173





# SILENT ABSORPTION REFRIGERATORS



## PRECISION COOLING FOR SENSITIVE PHARMACEUTICALS

Medicines, vaccines and other sensitive pharmaceuticals are safely stored in the DS series silent absorption refrigerators. The interior has a constant, even temperature that is monitored by an external thermometer. Practical drawers with a high, transparent front provide convenient handling and minimal loss of refrigeration when opening.

Quality features: External thermometer with min/max memory, plastic drawers with 1/2 extension and high, transparent front, LED interior lighting, door lock, replaceable door hinge. DS refrigerators can be built in. Please note that the hinge cannot be reversed.

## DOMETIC DS SERIES

Medical absorption refrigerators

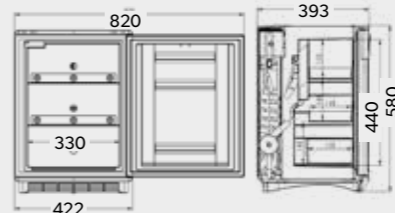
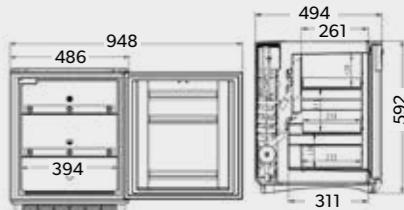
	DS 301 H	DS 601 H
DS 301 H		
DS 601 H		
<b>Gross capacity</b>	approx. 27 litres	approx. 53 litres
<b>Voltage</b>	230 V	230 V
<b>Average power consumption</b>	65 W	85 W
<b>Temperature range</b>	Fixed point temperature +5 °C, ±3 °C variation	Fixed point temperature +5 °C, ±3 °C variation
<b>Insulation</b>	PU full foam insulation	PU full foam insulation
<b>System</b>	Silent absorption refrigeration for normal interior temperatures	Silent absorption refrigeration for normal interior temperatures
<b>Material</b>	Full-trim plastic housing with rear-wall cover	Full-trim plastic housing with rear-wall cover
<b>Colour</b>	Housing: white; door: white	Housing: white; door: white
<b>Weight</b>	approx. 15 kg	approx. 20 kg
<b>Exterior dimensions (H x W x D)</b>	580 x 422 x 393 mm	592 x 486 x 494 mm
<b>Quality features</b>	External thermometer with min/max memory for monitoring the interior temperature, can be integrated (not with variable hinge), plastic drawers with 1/2 extension, LED interior lighting, door lock, replaceable door hinge	External thermometer with min/max memory for monitoring of interior temperature, can be integrated (not with variable hinge), plastic drawers with 1/2 extension, LED interior lighting, door lock
<b>Test marks</b>	e-approved (Automotive EMC Directive)	e-approved (Automotive EMC Directive)
<b>Product</b>		<b>Ref. No.</b> <b>Ref. No. UK</b>
Dometic DS 301 H		9600027080    9600027083
Dometic DS 601 H		9600027074
	DS 301 H	DS 601 H
		



# POWERFUL, ENERGY-EFFICIENT COMPRESSOR REFRIGERATORS

**DIN 58345 COMPLIANT VERSIONS AVAILABLE**

When it comes to storing medicine safely at high ambient temperatures, we recommend a refrigerator with a powerful compressor system. Our HC series devices have an integrated illuminated temperature display. High-quality roll-out metal drawers which can be extended to 3/4 of their depth offer well-organised storage. Quality features: Integrated thermometer with min/max

memory, illuminated temperature display, high-quality, roll-out metal drawers with 3/4 extension and plastic front, LED interior lighting, door lock. HC refrigerators can be built in. Please note that the hinge cannot be reversed. HC 302 / HC 502 are optionally available as DIN 58345 compliant model versions (HC 302D / HC 502D).

## DOMETIC HC SERIES

Medical compressor refrigerators

	HC 302FS / HC 302D	HC 502FS / HC 502D	
<p>HC 302 / HC 302D</p>  <p>HC 502 / HC 502D</p> 	<b>Gross capacity</b>	approx. 33 litres	approx. 49 litres
	<b>Voltage</b>	230 V	230 V
	<b>Average power consumption</b>	40 W	40 W
	<b>Refrigerant</b>	R134a, Refrigerant quantity: 38 g, CO <sub>2</sub> equivalent: 0.054 t, Global warming potential (GWP): 1430	
	<b>Temperature range</b>	Fixed point temperature +5 °C, ±3 °C variation	Fixed point temperature +5 °C, ±3 °C variation
	<b>Insulation</b>	PU full foam insulation	
	<b>System</b>	Powerful compressor cooling – even under high ambient temperatures	
	<b>Material</b>	Full-trim plastic housing with rear-wall cover	
	<b>Colour</b>	Housing: white; door: white	
	<b>Weight</b>	approx. 17 kg	approx. 21 kg
<b>Exterior dimensions (H x W x D)</b>	580 x 422 x 450 mm	592 x 486 x 494 mm	
<b>Quality features</b>	Integrated thermometer with min/max memory, illuminated temperature display, high-quality roll-out metal drawers with 3/4 extension and plastic front, LED interior lighting, door lock	Integrated thermometer with min/max memory, illuminated temperature display, high-quality roll-out metal drawers with 3/4 extension and plastic front, LED interior lighting, door lock	
<b>Certified according to DIN 58345</b>	<ul style="list-style-type: none"> <li>Temperature variation alarm</li> <li>Power failure alarm</li> <li>External, potential free contact for alarm transmission</li> <li>AC powered display (no batteries)</li> </ul>	<ul style="list-style-type: none"> <li>Temperature variation alarm</li> <li>Power failure alarm</li> <li>External, potential free contact for alarm transmission</li> <li>AC powered display (no batteries)</li> </ul>	
<b>Test marks</b>	e-approved (Automotive EMC Directive)		
<b>Product</b>	<b>Ref. No.</b>	<b>Ref. No. UK</b>	
Dometic HC 302FS	9105204209		
Dometic HC 302D	9105204421	9105204423	
Dometic HC 502FS	9105204215		
Dometic HC 502D	9105204425	9105204427	

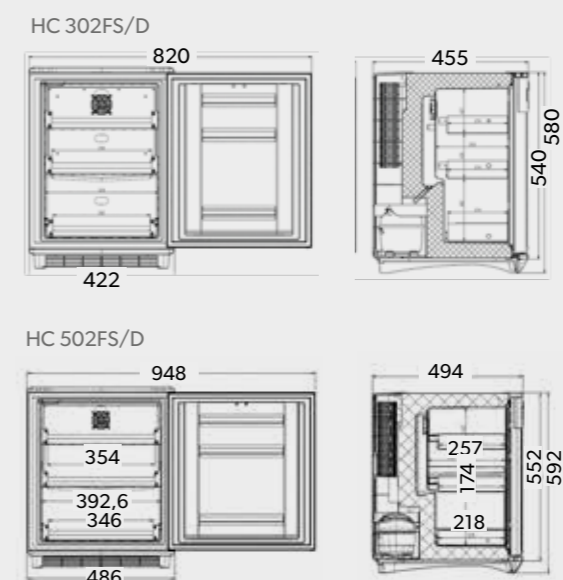





# BUILT-IN HEATING CABINETS AND REFRIGERATORS

WITH HYGIENIC STAINLESS STEEL FRONT

Cooling or heating with  $\pm 1\text{ }^{\circ}\text{C}$  accuracy: Dometic's innovative generation of refrigerator and warmer cabinets was specifically designed for use in emergency vehicles. The interior temperature is

limited at  $+5\text{ }^{\circ}\text{C}$  or, respectively,  $+37\text{ }^{\circ}\text{C} (\pm 1\text{ }^{\circ}\text{C})$ . This, combined with well thought-out details, qualifies the cabinets for other applications, too.

## DOMETIC COOLMATIC MH 07 / MR 07 / MRR 07

Medical compressor refrigerators

	MH 07	MR 07	MRR 07
<p>MH 07</p>  <p>MR 07</p>  <p>MRR 07</p> 	<b>Gross capacity</b> approx. 7 litres	<b>Connection voltage</b> 12 volts DC	
	<b>Average power consumption</b> approx. 15 to 20 watts	approx. 36 watts	
	<b>Temperature range</b> Fixed point temperature at $+37\text{ }^{\circ}\text{C} (\pm 1\text{ }^{\circ}\text{C})$	Fixed point temperature at $+5\text{ }^{\circ}\text{C} (\pm 1\text{ }^{\circ}\text{C})$	
	<b>Refrigerant</b> R134a, Refrigerant quantity: 45 g, CO <sub>2</sub> equivalent: 0.064 t, Global warming potential (GWP): 1430	<b>Insulation</b> Polyurethane	
	<b>System</b> 12-volt heating resistor	Fully hermetic compressor with integrated control electronics, low-voltage protection, electronic fuse / automatic reverse pole protection, dynamically ventilated wire tube condenser, foam-backed three sided rear panel vaporiser	
	<b>Material</b> Door and flush-mount installation frame: stainless steel; Inner container: plastic	<b>Colour</b> Front: silver. Interior: white	
	<b>Weight</b> approx. 4.5 kg	approx. 10 kg	approx. 10 kg
	<b>Dimensions (W x H)</b> 245 x 350 mm (installation space)	<b>Quality features</b> Fixed point temperature set at $+37\text{ }^{\circ}\text{C} (\pm 1\text{ }^{\circ}\text{C})$ , optimum temperature distribution with additional, durable fan in the back wall of the interior, digital temperature display built into the stainless steel installation frame – no third party access possible, interior light, shelves with three heights, recessed door grip, door hinges and lock variable right / left.	
	<b>Test marks</b> e-approved (Automotive EMC Directive)	<b>Quality features</b> Fixed point temperature set at $+5\text{ }^{\circ}\text{C} (\pm 1\text{ }^{\circ}\text{C})$ , optimum temperature distribution with additional, durable fan in the back wall of the interior, digital temperature display built into the stainless steel installation frame – no third party access possible, interior light, shelves with three heights, recessed door grip, door hinges and lock variable right / left. For smaller space requirements, the unit can also be fitted at the side (right or left) of the model or at a distance of up to 1.5 m.	
	<b>Product</b>	<b>Ref. No.</b>	
Dometic MH 07	9105204551		
Dometic MR 07	9105204550		
Dometic MRR 07	9105204552		

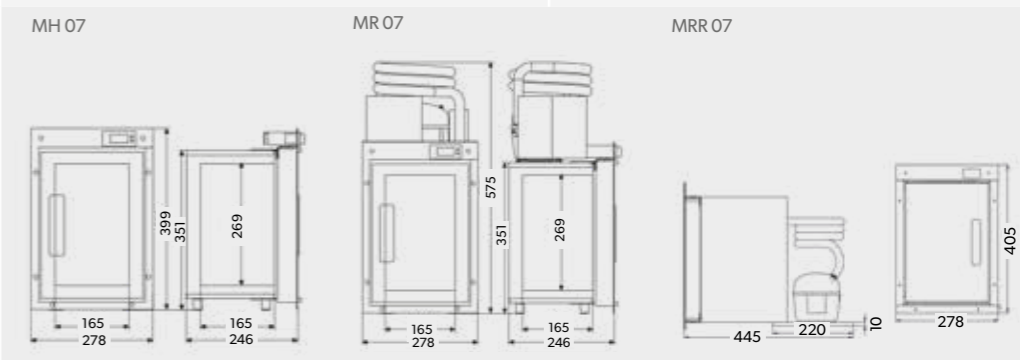





# ONE-DEGREE ACCURACY

## CUSTOMISED COOLING SOLUTIONS FOR TEMPERATURE-CONTROLLED TRANSPORT

Taking highly perishable goods safely from one place to another – no problem with mobile refrigeration by Dometic. Our portable coolers have stood and passed the test of practice millions of times. To meet your demanding logistics needs they are fitted with special, high-performance electronics. Whatever it is you are transporting – lab samples, veterinary samples or specimens, temperature-sensitive medicines or perishable food – Dometic products provide one-degree accuracy for your freight!

- All products have been developed in compliance with the strict guidelines of HACCP and GDP.
- All Dometic production plants are certified according to ISO 9001, ISO 14001 as well as the EU Eco-Management and Audit Scheme.
- As an EMAS-certified company, we publish all environmental results as part of the Dometic Environmental Product Declaration.



## THERMOELECTRIC AND COMPRESSOR COOLERS

Easy customising: All coolers can be equipped for temperature controlled transport – e.g. with a data logger, smartphone app or a factory-preset fixed temperature.

PAGE 176 – 185



## FULLY INTEGRATED COOLING SYSTEMS FOR VEHICLES

Customised cooling systems to suit specific vehicles, cargo capacities and temperature conditions. Fully integrated in the vehicle with no roof-mounted structures.

PAGE 186 – 191



## REFRIGERATION AND DEEP-FREEZE CONTAINERS

Available as a front loader or top loader, in different sizes. With factory-preset fixed temperature and smart details for convenient handling.

PAGE 192 – 197





# TROPICOOOL

## HIGH-TECH FOOD COOLER AND WARMER

### DOMETIC TROPICOOOL TCX 14

Thermoelectric cooler with TC special electronics

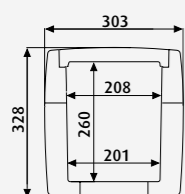
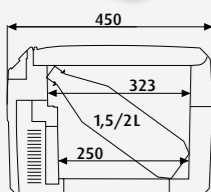

<b>Storage volume</b>	approx. 14 litres	
<b>Connection voltage</b>	12/24 volts DC and 230 volts AC	
<b>Power consumption</b>	approx. 46 watts at 12 volts DC; approx. 50 watts at 24 volts DC; approx. 64 watts at 230 volts	
<b>Energy class</b>	A++	
<b>Temperature range</b>	Cooling: +1 °C to +15 °C (up to 27 °C below the ambient temperature); heating: +50 °C to +65 °C	
<b>Insulation</b>	PU full foam insulation	
<b>System</b>	Wear-free thermoelectrics (Peltier system), cold transmission to the interior by dynamically ventilated aluminium heat exchanger, heat dissipation to the outside by high-performance heat exchanger and brushless, no wear and tear on the fan	
<b>Material</b>	Sturdy, injection moulded parts	
<b>Colour</b>	Dark grey/pale grey	
<b>Weight</b>	approx. 5.0 kg	
<b>Quality features</b>	TC special electronics: 7-stage electronic thermostat with LED indicators, memory function, ON/OFF and cold/warm option activated with soft-touch operating panel, intelligent powersave circuit. Integrated mains supply unit with priority circuit, outstanding cooling performance, with active battery protection, reverse polarity protection, magnetic switch to deactivate the interior fan when the box is opened, detachable lid with magnetic closure, sturdy, fold-away handle	
<b>Test marks</b>	TÜV/GS, e-approved (Automotive EMC Directive)	
<b>Product</b>	<b>Ref. No.</b>	<b>Ref. No. UK</b>
Dometic TropiCool TCX 14	9103540486	9600010637
<b>/ Optional extras</b>		
Universal fixing kit	9105303709	

### UNIVERSAL FIXING KIT

For TropiCool TCX 14, TCX 21, TCX 35: For fastening of TropiCool coolers in vehicles.



<b>Material</b>	Powder-coated metal
<b>Colour</b>	Black
<b>Scope of delivery</b>	Two base plates, two adjustable straps, set of screws
<b>Product</b>	<b>Ref. No.</b>
Universal fixing kit	9105303709

### DOMETIC TROPICOOOL TCX 21

Thermoelectric cooler with TC special electronics

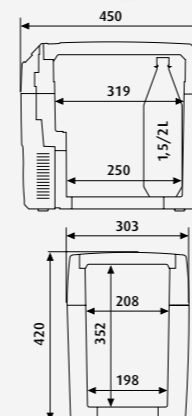

<b>Storage volume</b>	approx. 20 litres	
<b>Connection voltage</b>	12/24 volts DC and 230 volts AC	
<b>Power consumption</b>	approx. 46 watts at 12 volts DC; approx. 50 watts at 24 volts DC; approx. 64 watts at 230 volts	
<b>Energy class</b>	A++	
<b>Temperature range</b>	Cooling: +1 °C to +15 °C (up to 27 °C below the ambient temperature); heating: +50 °C to +65 °C	
<b>Insulation</b>	PU full foam insulation	
<b>System</b>	See TCX 14	
<b>Material</b>	Sturdy, injection moulded parts	
<b>Colour</b>	Dark grey/pale grey	
<b>Weight</b>	approx. 6.0 kg	
<b>Quality features</b>	TC special electronics: 7-stage electronic thermostat with LED indicators, memory function, ON/OFF and cold/warm option activated with soft-touch operating panel, intelligent powersave circuit. Integrated mains supply unit with priority circuit, outstanding cooling performance, with active battery protection, reverse polarity protection, magnetic switch to deactivate the interior fan when the box is opened, detachable lid with magnetic closure, sturdy, fold-away handle, vertical space for 2 litre bottles, adjustable grid divider	
<b>Test marks</b>	TÜV/GS, e-approved (Automotive EMC Directive)	
<b>Product</b>	<b>Ref. No.</b>	<b>Ref. No. UK</b>
Dometic TropiCool TCX 21	9103540487	9600010638
<b>/ Optional extras</b>		
Universal fixing kit	9105303709	

### DOMETIC TROPICOOOL TCX 35

Thermoelectric cooler with TC special electronics

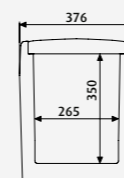
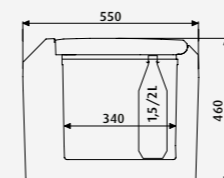

<b>Storage volume</b>	approx. 33 litres	
<b>Connection voltage</b>	12/24 volts DC and 230 volts AC	
<b>Power consumption</b>	approx. 46 watts at 12 volts DC; approx. 50 watts at 24 volts DC; approx. 64 watts at 230 volts	
<b>Energy class</b>	A++	
<b>Temperature range</b>	Cooling: +1 °C to +15 °C (up to 27 °C below the ambient temperature); heating: +50 °C to +65 °C	
<b>Insulation</b>	PU full foam insulation	
<b>System</b>	See TCX 14	
<b>Material</b>	Sturdy, injection moulded parts	
<b>Colour</b>	Dark grey/pale grey	
<b>Weight</b>	approx. 10.0 kg	
<b>Quality features</b>	TC special electronics: 7-stage electronic thermostat with LED indicators, memory function, ON/OFF and cold/warm option activated with soft-touch operating panel, intelligent powersave circuit. Integrated mains supply unit with priority circuit, outstanding cooling performance, with active battery protection, reverse polarity protection, magnetic switch to deactivate the interior fan when the box is opened, detachable lid with snap lock closure, handy carrying grips, vertical space for 2-litre bottles, adjustable grid divider	
<b>Test marks</b>	TÜV/GS, e-approved (Automotive EMC Directive)	
<b>Product</b>	<b>Ref. No.</b>	<b>Ref. No. UK</b>
Dometic TropiCool TCX 35	9103540488	9600010639
<b>/ Optional extras</b>		
Universal fixing kit	9105303709	

# CUSTOMISING WITH EXTRA MODULES

## DATA LOGGER FOR EASY DOCUMENTATION

For the sake of continuous, tamper-proof temperature recording, the DT-07N data logger is firmly integrated in the cooler. The data is imported into the laptop via a data transfer cable with USB – or printed out directly using the clip-on printer. Alternatively, we offer a disposable data logger for documenting the temperature progression (DT-21).



# EXTRA MODULES FOR THERMOELECTRIC COOLERS

THERMOELECTRIC COOLERS	DTTC-02 ONE FACTORY PRESET FIXED TEMPERATURE	DT-07N DATA LOGGER	DT-08N THERMAL PRINTER INCL. DATA LOGGER WITH SOFTWARE	DTTC-09 TWO FACTORY PRESET FIXED TEMPERATURES	DT-13 3-PIN PLUG-IN SYSTEM	DTTC-17 ALARM FUNCTION	DT-21 DISPOSABLE DATA LOGGER
TCX 14	•	•	•	•	•	•	•
TCX 21	•	•	•	•	•	•	•
TCX 35	•	•	•	•	•	•	•



# EXTRA MODULES FOR THERMOELECTRIC COOLERS



### DTTC-02

Setting a fixed temperature in the range from +10 °C to +40 °C (automatic heating or cooling). Max. 27 °C below or 30 °C above ambient temperature. With digital temperature display. Tolerance: ±2 °C. Test report included in the scope of delivery.

Ref. No. 9600024729



### DTTC-09

Two fixed temperatures in a range from +10 °C to +40 °C (automatic heating or cooling). Max. 27 °C below or 40 °C above ambient temperature. With digital temperature display. Easy change from one value to another with rocker switch. Tolerance: ±2 °C. Test report included in the scope of delivery.

Ref. No. 9600024730



### DTTC-17

Alarm will be triggered by a deviation from the target temperature ±4.0 °C lasting more than 5 min. The alarm function is activated 20 min after the cooler starts operating. In combination with DTTC-02 and DTTC-09 only!

Ref. No. 9103540026



### DT-07N

Temperature data logger as a single unit, without software. Software download from [www.testo.com](http://www.testo.com)

Ref. No. 9103540007



### DT-21

Disposable data logger for recording temperature in the cooler. Up to 90 days recording time following activation (USB interface)

Ref. No. 9103540134



### DT-08N

Thermal printer for displaying the temperature variation graphically (to be used in combination with DT-07N).

Ref. No. 9103540008



### DT-13

3-pin plug-in system for built-in power supply. Max. power consumption: 25 A at 12 volts. Flat terminals (4 x 6.3 mm or 1 x 4.8 mm).

Ref. No. 2225400001



**DOMETIC COOLFREEZE CDF 11**

Portable compressor cooler for refrigeration and deep-freezing

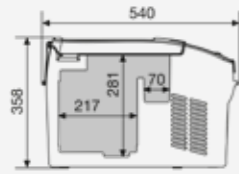

<b>Storage volume</b>	approx. 10.5 litres
<b>Connection voltage</b>	12/24 volts DC
<b>Power consumption</b>	approx. 35 watts
<b>Current consumption</b> at +5 °C interior temperature	0.29 Ah/h (at +20 °C ambient temperature) 0.61 Ah/h (at +32 °C ambient temperature)
<b>Temperature range</b>	The cooling circuit contains the fluorinated greenhouse gas R134a (28 g), CO <sub>2</sub> equivalent: 0.042 t, GWP: 1430
<b>Refrigerant</b>	+10 °C to -18 °C, adjustable using electronic thermostat
<b>Insulation</b>	PU full foam insulation
<b>System</b>	Compressor with integrated control electronics, low voltage protection (can be disabled), electronic fuse/automatic reverse pole protection
<b>Material</b>	Housing: PP; lid: PE
<b>Colour</b>	Dark grey/pale grey
<b>Weight</b>	approx. 8.5 kg
<b>Quality features</b>	Electronic thermostat with digital temperature display, 3-stage battery monitor, LED interior light, adjustable shoulder strap, two drink holders, easy and secure fastening with the vehicle safety belt
<b>Scope of delivery</b>	DC connection cable
<b>Test marks</b>	e-approved (Automotive EMC Directive)

Product	Ref. No.
Dometic CoolFreeze CDF 11	9103540285
/ Optional extras see page 185	

**DOMETIC COOLFREEZE CDF 18**

Portable compressor cooler for refrigeration and deep-freezing

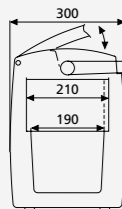
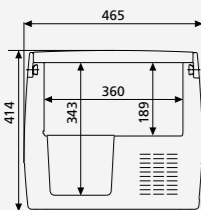

<b>Storage volume</b>	approx. 18 litres
<b>Connection voltage</b>	12/24 volts DC
<b>Power consumption</b>	approx. 35 watts
<b>Current consumption</b>	0.38 Ah/h at +20 °C ambient temperature, 0.61 Ah/h at +32 °C ambient temperature, both at +5 °C interior temperature
<b>Refrigerant</b>	The cooling circuit contains the fluorinated greenhouse gas R134a (32 g), CO <sub>2</sub> equivalent: 0.046 t, GWP: 1430
<b>Temperature range</b>	+10 °C to -18 °C, adjustable using electronic thermostat
<b>Insulation</b>	PU full foam insulation
<b>System</b>	Compressor with integrated control electronics, low voltage protection adjustable for leisure and starter battery via slide switch, electronic fuse / automatic reverse pole protection, dynamically ventilated wire tube condenser, aluminium rollbond evaporator
<b>Material</b>	Housing: PP; lid: PE
<b>Colour</b>	Dark grey/pale grey
<b>Weight</b>	approx. 9.5 kg
<b>Quality features</b>	Detachable fold-up lid, sturdy carrying handle, vertical space for standing 2-litre bottles
<b>Scope of delivery</b>	DC connection cable
<b>Test marks</b>	TÜV/GS, e-approved (Automotive EMC Directive)

Product	Ref. No.
Dometic CoolFreeze CDF 18	9103540485
/ Optional extras see page 185	
EPS 100 Mains adapter 230 V • 24 V	9600000440

**DOMETIC COOLFEEZE CFX 35W**

Energy-saving compressor cooler for refrigeration and deep-freezing

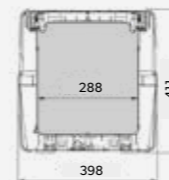
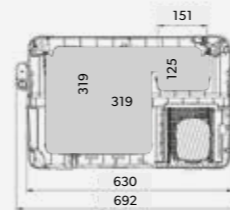

<b>Storage volume</b>	32 litres (incl. 4.5 litres for fresh food)
<b>Connection voltage</b>	12/24 volts DC and 100 – 240 volts AC
<b>Power consumption</b>	approx. 43 watts
<b>Current consumption</b> both at +5 °C interior temperature	0.32 Ah/h (at +20 °C ambient temperature), 0.60 Ah/h (at +32 °C ambient temperature),
<b>Energy class</b>	A++
<b>Temperature range</b>	+10 °C to -22 °C, freely adjustable using electronic thermostat with digital temperature display
<b>Refrigerant</b>	The cooling circuit contains the fluorinated greenhouse gas R134a (38 g), CO <sub>2</sub> equivalent: 0.047 t, GWP: 1430
<b>Insulation</b>	PU full foam insulation
<b>System</b>	Fully hermetic compressor with integrated control electronics, low voltage protection adjustable for leisure and starter battery via electronic system, electronic fuse / automatic reverse pole protection, dynamically ventilated wire tube condenser, aluminium rollbond evaporator
<b>Material</b>	Cabinet: PP + ABS, lid: PE
<b>Colour</b>	Dark grey/pale grey
<b>Weight</b>	approx. 17.5 kg
<b>Quality features</b>	Detachable lid (lid mount, at the front), interior light, CFX special electronics with soft start and turbo cooler, removable wire basket, 3-stage battery protection
<b>Scope of delivery</b>	DC- and AC connection cable
<b>Test marks</b>	TÜV/GS, e-approved (Automotive EMC Directive)

Product	Ref. No. / Ref. No. UK
Dometic CoolFreeze CFX 35W	9103540290 / 9600010568
/ Optional extras	
Trolley	see page 185

## DOMETIC COOLFREEZE CFX 40W

Compressor cooler for refrigeration and deep-freezing with CFX special electronics

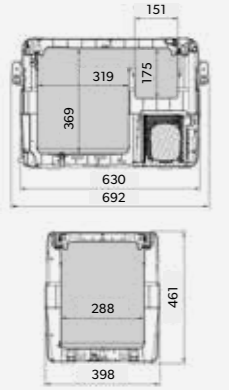
	<b>Storage volume</b>	38 litres (incl. 7 litres for fresh food)
	<b>Connection voltage</b>	12/24 volts DC and 100 – 240 volts AC
	<b>Power consumption</b>	approx. 48 watts
	<b>Current consumption at +5 °C interior temperature</b>	0.36 Ah/h (at +20 °C ambient temperature) 0.64 Ah/h (at +32 °C ambient temperature)
	<b>Energy class</b>	A++
	<b>Temperature range</b>	+10 °C to –22 °C, freely adjustable using electronic thermostat with digital temperature display
	<b>Refrigerant</b>	The cooling circuit contains the fluorinated greenhouse gas R134a (38 g), CO <sub>2</sub> equivalent: 0.054 t, GWP: 1430
	<b>Insulation</b>	PU full foam insulation
	<b>System</b>	see CFX 100W
	<b>Material</b>	Cabinet: PP + ABS, lid: PE
	<b>Colour</b>	Dark grey/pale grey
	<b>Weight</b>	approx. 18.5 kg
	<b>Quality features</b>	Deep freezing down to –22 °C, excellent cooling performance even at extremely high outside temperatures, special CFX electronics with digital temperature display, extremely efficient and superbly quiet operation, USB connection, drain plugs make cleaning simple
	<b>Scope of delivery</b>	DC and AC connection cable, detachable wire basket, detachable carrying handles
	<b>Test marks</b>	TÜV/GS, e-approved (Automotive EMC Directive)
	<b>Product</b>	<b>Ref. No. / Ref. No. UK</b>
	Dometic CoolFreeze CFX 40W	9103540291 / 9600010569
	<b>/ Optional extras</b>	
	Trolley	see page 185

## DOMETIC COOLFREEZE CFX 50W

Compressor cooler for refrigeration and deep-freezing with CFX special electronics

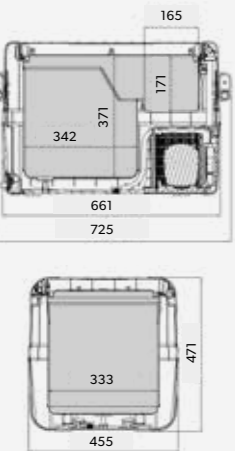
	<b>Storage volume</b>	approx 46 litres (incl. 8.5 litres for fresh food)
	<b>Connection voltage</b>	12/24 volts DC and 100 – 240 volts AC
	<b>Power consumption</b>	approx. 52 watts
	<b>Current consumption at +5 °C interior temperature</b>	0.38 Ah/h (at +20 °C ambient temperature) 0.68 Ah/h (at +32 °C ambient temperature)
	<b>Energy class</b>	A++
	<b>Temperature range</b>	+10 °C to –22 °C, freely adjustable using electronic thermostat with digital temperature display
	<b>Refrigerant</b>	The cooling circuit contains the fluorinated greenhouse gas R134a (43 g), CO <sub>2</sub> equivalent: 0.062 t, GWP: 1430
	<b>Insulation</b>	PU full foam insulation
	<b>System</b>	see CFX 100W
	<b>Material</b>	Housing: PP + ABS, lid: PE
	<b>Colour</b>	Dark grey/pale grey
	<b>Weight</b>	approx. 20.4 kg
	<b>Quality features</b>	Deep freezing down to –22 °C, excellent cooling performance even at extremely high outside temperatures, special CFX electronics with digital temperature display, extremely efficient and superbly quiet operation, USB connection, drain plugs make cleaning simple
	<b>Scope of delivery</b>	DC and AC connection cable, detachable wire basket, detachable carrying handles
	<b>Test marks</b>	TÜV/GS, e-approved (Automotive EMC Directive)
	<b>Product</b>	<b>Ref. No. / Ref. No. UK</b>
	Ref. No.	9103540292 / 9600010602
	<b>/ Optional extras</b>	
	Trolley	see page 185

## DOMETIC COOLFREEZE CFX 65W

Compressor cooler for refrigeration and deep-freezing with CFX special electronics

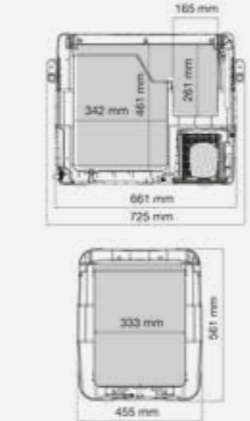
	<b>Storage volume</b>	approx. 60 litres (incl. 13 litres for fresh food)
	<b>Connection voltage</b>	12/24 volts DC and 100 – 240 volts AC
	<b>Power consumption</b>	approx. 58 watts
	<b>Current consumption at +5 °C interior temperature</b>	0.42 Ah/h (at +20 °C ambient temperature) 0.76 Ah/h (at +32 °C ambient temperature)
	<b>Energy class</b>	A++
	<b>Temperature range</b>	+10 °C to –22 °C, freely adjustable using electronic thermostat with digital temperature display
	<b>Refrigerant</b>	The cooling circuit contains the fluorinated greenhouse gas R134a (57 g), CO <sub>2</sub> equivalent: 0.082 t, GWP: 1430
	<b>Insulation</b>	PU full foam insulation
	<b>System</b>	see CFX 100W
	<b>Material</b>	Housing: PP + ABS, lid: PE
	<b>Colour</b>	Dark grey/pale grey
	<b>Weight</b>	approx. 22.3 kg
	<b>Quality features</b>	see CFX 50W
	<b>Scope of delivery</b>	DC and AC connection cable, detachable wire basket, detachable carrying handles
	<b>Test marks</b>	TÜV/GS, e-certified (Automotive EMC Directive)
	<b>Product</b>	<b>Ref. No. / Ref. No. UK</b>
	Dometic CoolFreeze CFX 65W	9103540293 / 9600010603
	<b>/ Optional extras</b>	
	Trolley	see page 185

## DOMETIC COOLFREEZE CFX 100W

Compressor cooler for refrigeration and deep-freezing with CFX special electronics

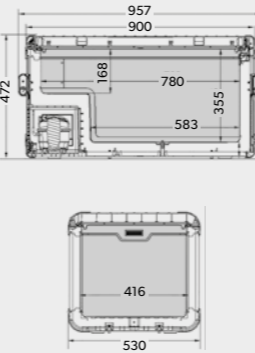
	<b>Storage volume</b>	approx. 88 litres
	<b>Connection voltage</b>	12/24 volts DC and 100 – 240 volts AC
	<b>Power consumption</b>	approx. 65 watts
	<b>Current consumption at +5 °C interior temperature</b>	0.75 Ah/h (at +20 °C ambient temperature) 1.25 Ah/h (at +32 °C ambient temperature)
	<b>Energy class</b>	A++
	<b>Temperature range</b>	+10 °C to –22 °C, freely adjustable using electronic thermostat with digital temperature display
	<b>Refrigerant</b>	The cooling circuit contains the fluorinated greenhouse gas R134a (64 g), CO <sub>2</sub> equivalent: 0.092 t, GWP: 1430
	<b>Insulation</b>	PU full foam insulation
	<b>System</b>	Fully hermetic compressor with integrated control electronics, low voltage protection adjustable for leisure and starter battery via electronic system, electronic fuse / automatic reverse pole protection, dynamically ventilated wire tube condenser, aluminium rollbond evaporator
	<b>Material</b>	Housing: PP + ABS, lid: PE
	<b>Colour</b>	Dark grey/pale grey
	<b>Weight</b>	approx. 32 kg
	<b>Quality features</b>	see CFX 50W
	<b>Scope of delivery</b>	DC and AC connection cable, detachable wire basket, detachable carrying handles
	<b>Test marks</b>	TÜV/GS, e-certified (Automotive EMC Directive)
	<b>Product</b>	<b>Ref. No. / Ref. No. UK</b>
	Ref. No.	9600002992 / 9600010636
	<b>/ Optional extras</b>	
	Trolley	see page 185



# EXTRA MODULES FOR COMPRESSOR COOLERS

	DT-02 ONE FACTORY PRESET FIXED TEMPERATURE	DT-09 TWO FACTORY PRESET FIXED TEMPERATURES	DT-04 INTERIOR FAN	DT-05* HEATER WITH THREE-POINT CONTROL	DT-17 ALARM FUNCTION	DT-07N DATA LOGGER	DT-08N THERMAL PRINTER	DT-21 DISPOSABLE DATA LOGGER	DT-29 BATTERY PACK	DT-13 3-PIN PLUG-IN SYSTEM	DT-15 TROLLEY
CDF 11	•	•	•		•	•	•	•	•	•	•
CDF 18	•	•	•	•	•	•	•	•	•	•	•
CFX 35W	•	•	•	•	•	•	•	•	•	•	•
CFX 40W	•	•	•	•	•	•	•	•	•	•	•
CFX 50W	•	•	•	•	•	•	•	•	•	•	•
CFX 65W	•	•	•	•	•	•	•	•	•	•	•
CFX 100W	•	•	•	•	•	•	•	•	•	•	•

\* Operation with 12 or 24 volts only. Operation with 230 volts not possible. Except CFX 100W.



## DT-17

Alarm will be triggered by a deviation from the target temperature  $\pm 4.0$  °C lasting more than 5 min. The alarm function is activated 20 min after the cooler starts operating. In combination with DT-04 and DT-02 or DT-09 only!

Ref. No. 9103540015



## DT-07N

Temperature data logger as a single unit, without software. Software download from [www.testo.com](http://www.testo.com)

Ref. No. 9103540007

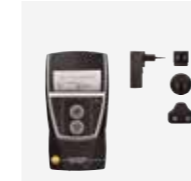

## DT-08N

Thermal printer for displaying the temperature variation graphically (to be used in combination with DT-07N).

Ref. No. 9103540008



## DT-21

Disposable data logger for recording temperature in the cooler. Up to 90 days recording time following activation (USB interface)

Ref. No. 9103540134



## DT-29

Battery pack for the power supply of 24-volt compressor coolers  
Energy = 240 Wh

Ref. No. 9600005902



## DT-13

3-pin plug-in system for built-in power supply. Max. power consumption: 25 A at 12 volts. Flat terminals (4 x 6.3 mm or 1 x 4.8 mm).

Ref. No. 2225400001



## DT-15

Folding trolley with elastic strap and large, easy-running wheels. Only available when purchasing a cooler!

490 x 1130 x 410 mm (W x H x D)

Ref. No. 9103540013



## DT-02

One fixed temperature (cooling only) with digital temperature display in a range from  $-18$  °C (CDF) /  $-22$  °C (CFX) to  $+10$  °C. Tolerance:  $\pm 2$  °C. Test report included in the scope of delivery. If the set temperature is above the expected lowest ambient temperature, the DT 05 heater is required.

Ref. No. 9600024731



## DT-09

Two fixed temperatures (cooling only) with digital temperature display in a range from  $-18$  °C (CDF) /  $-22$  °C (CFX) to  $+10$  °C. Easy change from one value to another with rocker switch. Tolerance:  $\pm 2$  °C. Test report included in the scope of delivery. If the set temperature is above the expected lowest ambient temperature, the DT 05 heater is required.

Ref. No. 9600024732

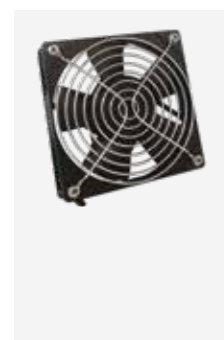

## DT-04

High-performance fan for fast cooling or heating and uniform air circulation inside the box (recommended for CFX series). Storage capacity will be reduced by approx. 100 x 100 x 30 mm WxHxD.

Ref. No. 9103540004

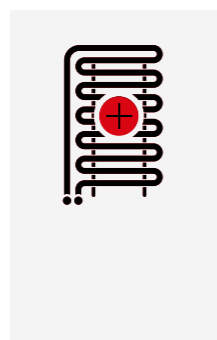

## DT-05

Heater for safer operation at low outside temperatures (if set temperature is above the ambient temperature). Includes DT 04 fan. Operation with 12 or 24 volts only. Operation with 230 volts not possible. Except CFX 100W.

Ref. No. 9103540005



## PORTABLE LITHIUM BATTERY SUPERIOR PERFORMANCE – RELIABLE POWER SUPPLY

The Dometic PLB40 Ah Lithium Iron Phosphate battery delivers high levels of mobile power – up to 40 hours of Dometic CFX 40W cooling on a single charge. Designed for powering powered coolers and other 12 V appliances while being off-grid. Thanks to its lightweight and compact design you can enjoy true independence and travel off-grid for longer.

Ref. No. 9600012878

For more information see [dometic.com](http://dometic.com)





# REFRIGERATION WITHOUT ATTACHING TO THE ROOF

ADAPTED TO FREIGHT AND VEHICLE

The transport of temperature-sensitive freight is a demanding logistic task subject to strict legal regulations. It calls for a vehicle that is equipped to take perishable foodstuffs, medicines or blood donations from one place to another with one-degree accuracy. The modular Dometic Frigo system provides highly reliable cooling solutions for all commonly used refrigerated vehicles. The entire refrigeration system is integrated in the vehicle where it takes up little space – and without the roof-mounted structure you typically have with other manufacturers' systems.

It takes just a few easy steps to create a customised precision cooling system. You start by specifying the type of vehicle, the size of the load compartment and the required temperature conditions. We then put together the modules to suit your specifications. If required, we add optional features such as a stationary cooling system to be operated from the control panel.



## CERTIFIED REFRIGERATION FOR RELIABLE COLD CHAIN MANAGEMENT

Companies transporting foodstuffs or other temperature-sensitive products have to meet strict legal requirements. They are responsible for ensuring that the cold chain is maintained throughout the product's way to the consumer. No problem – Dometic Frigo cooling systems for refrigerated vehicles are 100 % reliable. Our systems are ATP-approved and certified to DIN 8958, a standard regulating the performance and functioning of cooling systems for thermally insulated means of transportation. Customers can be sure they can transport their sensitive freight safely and reliably at all times.



## STAND-BY COOLING OPTION FOR DOMETIC FRIGO

The optional stand-by cooling kit optimises the logistic workflow. The vehicle can be loaded or remain loaded overnight so as to be ready in the morning to get on its way. There is no need to store the goods temporarily in a stationary cooling room. The compressor of the stand-by cooling kit is installed in the driver's cab underneath the seat; a 230 V external socket for connecting the system is built into the front bumper. As the cooling components of the installation are also supplied with on-board current in stationary mode, we have added a high-quality IUOU charger which ensures the vehicle battery is properly charged.

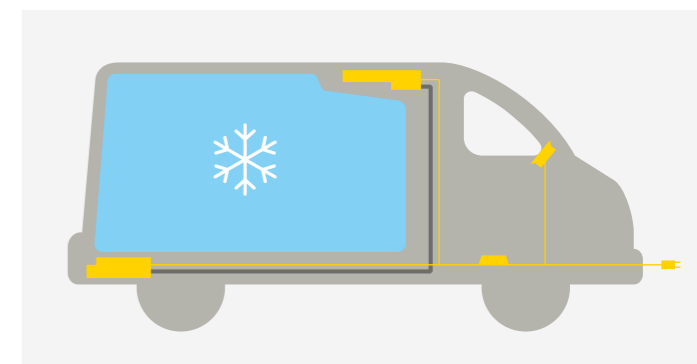

## FULLY INTEGRATED COOLING – NO ROOF-MOUNT STRUCTURE

Dometic Frigo refrigeration systems give you the unique benefit of fully integrated installation. The evaporator unit is fitted to the ceiling of the cargo compartment in a space-saving manner. It's never in the way – neither during loading and unloading, nor during clean-up. Unlike with other manufacturers' systems, there's no roof-mounted structure. **That means:**

- No problems with headroom restrictions, e.g. in underground car parks
- Safer driving even in tricky situations, because the vehicle's centre of gravity remains unchanged
- No roof cut-out required – the chassis' stability and anti-corrosion properties are preserved
- No impairment of the vehicle's appearance and aerodynamics

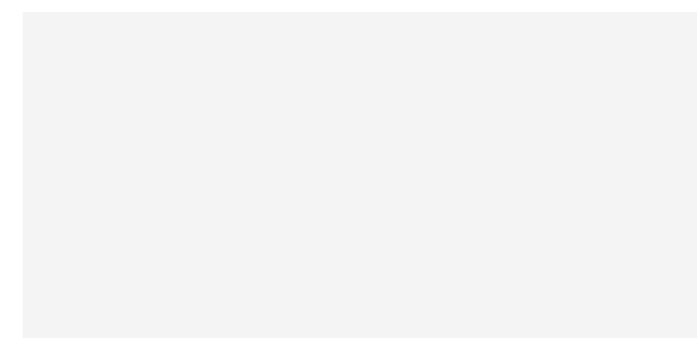

## HOT GAS DEFROSTING AS STANDARD OR OPTIONAL

Problems with long idle times when the evaporator is iced and needs to be thawed? Simply activate the Dometic Frigo hot gas defrosting system to get your vehicle back on the road in no time at all. It heats up the refrigerant between the compressor and evaporator and thaws the evaporator quickly, so it can work with full efficiency again.

**Hot gas defrosting is included as standard on Dometic Frigo DC systems, but optional on the Dometic Frigo version.**



# DOMETIC FRIGO DC – FULLY INTEGRATED ELECTRICAL REFRIGERATION SYSTEM

## HIGH FLEXIBLE TO VEHICLE SETUP







Today's compact van models offer little space for retrofitting a transport cooling systems. Quite often, it is impossible to integrate a belt-driving compressor in the engine compartment. The new generation Dometic Frigo DC systems solve this problem in a smart way. The compressor and the condenser are combined in a compact unit which is fitted in the spare wheel compartment. Like with all Dometic Frigo systems, the evaporator is mounted to the ceiling of the cargo hold.

## DOMETIC FRIGO DC ADAPTER KITS FOR FAST AND EASY INSTALLATION

Our vehicle-specific Dometic Frigo DC adapter kits allow fast and easy installation of the compressor-condenser unit. Available for the most common vans. Contact your local dealer for more information.

## DRIVING MODE COOLING PERFORMANCE

Dometic Frigo DC	30 °C Ext  			Air flow volume m <sup>3</sup> /h	Power consumption A	Dimensions Evaporator mm (W/H/D)	Total weight system kg
	Driving cooling						
	0 °C	+7 °C	+12 °C				
 DC 2500	1,030 W	1,325 W	1,565 W	780	68*	660 x 157 x 500	43
 DC 3500	1,125 W	1,445 W	1,670 W	1,140	85*	900 x 157 x 500	47
<b>Refrigerant</b>	<b>R 134a</b>						

Vehicle requirements: the vehicle must have minimum a 125 A alternator and a 90 A/h battery.  
(Data for driving mode, stationary mode varies) \*For outside temperature 30 °C and 0 °C inside temperature (according ATP)



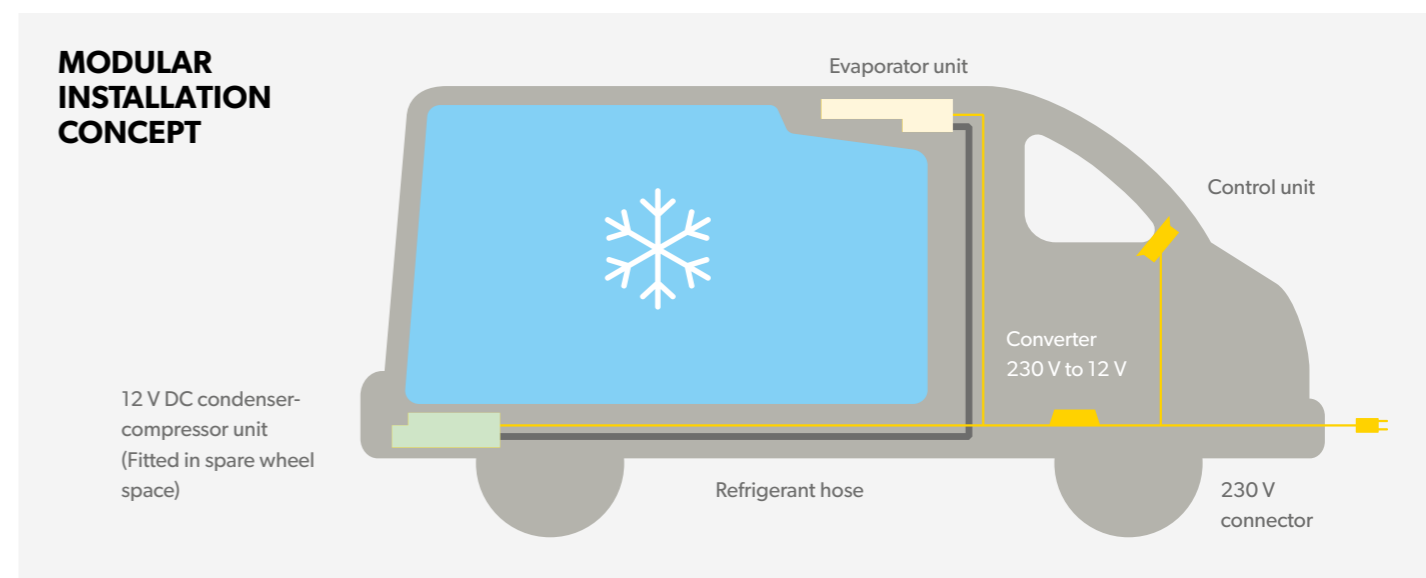

# DOMETIC FRIGO DC – THE SMARTEST AND EASIEST COOLING SYSTEM

- Combined compressor and condenser unit fitted in the spare wheel compartment giving faster and easier installation
- Variable speed compressor giving constant temperature control, higher performance and lower power consumption
- As no installation is required in the engine compartment it can be fitted to most vehicle
- Easy to service and maintain – less components, beltless compressor
- Integrated hotgas defrost function (serial)
- Intelligent compressor control unit which controls the RPM of the compressor and condenser fan according available energy (battery protection) and cooling performance requirement.
- Patented Power Management
- Approved according to automotive standards
- Easy to upgrade with stand-by cooling (battery charger and cable kit)

For detailed information about the Dometic Frigo modular system, please refer to the Dometic Frigo price and programme overview.



## DOMETIC FRIGO DC OVERVIEW

<b>EVAPORATOR DC 2500</b>		<b>EVAPORATOR DC 3500</b>	
<b>COMPRESSOR-CONDENSER UNIT</b>		<b>COMPRESSOR-CONDENSER UNIT</b>	
<b>HOSE, 4 M</b>		<b>HOSE, 6 M</b>	
<b>OPTIONAL</b>		<b>OPTIONAL</b>	
<b>VEHICLE ADAPTER KIT, STAND-BY KIT</b>		<b>VEHICLE ADAPTER KIT, STAND-BY KIT</b>	

# DOMETIC FRIGO – BELT DRIVEN SYSTEM



Dometic Frigo refrigeration systems comprise several components, some of which are available as options. The modular concept allows easy customising for refrigerated and deep-freeze applications. Reliable cooling at constant temperatures can be achieved for load compartment volumes up to 18 m<sup>3</sup>. Regardless of whether it's long distance or local distribution, continuous cooling is guaranteed at all times.

You start with selecting the right size of evaporator, then you add the matching condenser and compressor. All in all, it will take only 8 to 12 hours to install the three basic components.

### Our tip for deep-freeze applications



The Dometic Frigo DC kit includes all special components you need: hot gas defrosting for the evaporator and condensation drain, a low-pressure switch, and an oil separator.

## DRIVING MODE – REFRIGERATION R 134A

Dometic Frigo	30 °C Ext  			Air flow volume m <sup>3</sup> /h	Power consumption A
	0 °C	+ 6 °C	+ 12 °C		
	Driving cooling				
2500	1,752 W	2,107 W	2,524 W	780	22 A
3500	2,385 W	2,888 W	3,452 W	1,140	27 A
4500	2,454 W	3,051 W	3,589 W	1,560	31 A
Refrigerant	R 134a				

(Data for driving mode, stationary mode varies)

## DRIVING MODE – DEEP-FREEZE R 404A

Dometic Frigo	30 °C Ext  			Air flow volume m <sup>3</sup> /h	Power consumption A
	0 °C	-10 °C	-20 °C		
	Driving cooling				
2500	2,394 W	1,797 W	1,034 W	780	22 A
3500	2,496 W	2,016 W	1,334 W	1,140	27 A
4500	2,567 W	2,062 W	1,283 W	1,560	31 A
Refrigerant	R 404a				

(Data for driving mode, stationary mode varies)

For cargo rooms up to 18 m<sup>3</sup>

# MODULAR SYSTEM FOR EASY CUSTOMIZING

- Internal assembly of the evaporator – no impact on the appearance or the aerodynamic properties of the vehicle
- Nothing on the roof – no risk of damage when driving into underground car parks
- Safer when having to make sudden movements as the vehicle's centre of gravity is not changed
- No need to cut into the roof trusses or sheet panel – the chassis' torsional stability and anti-corrosion properties are preserved

For detailed information about the Dometic Frigo modular system, please refer to the Dometic Frigo price and programme overview.

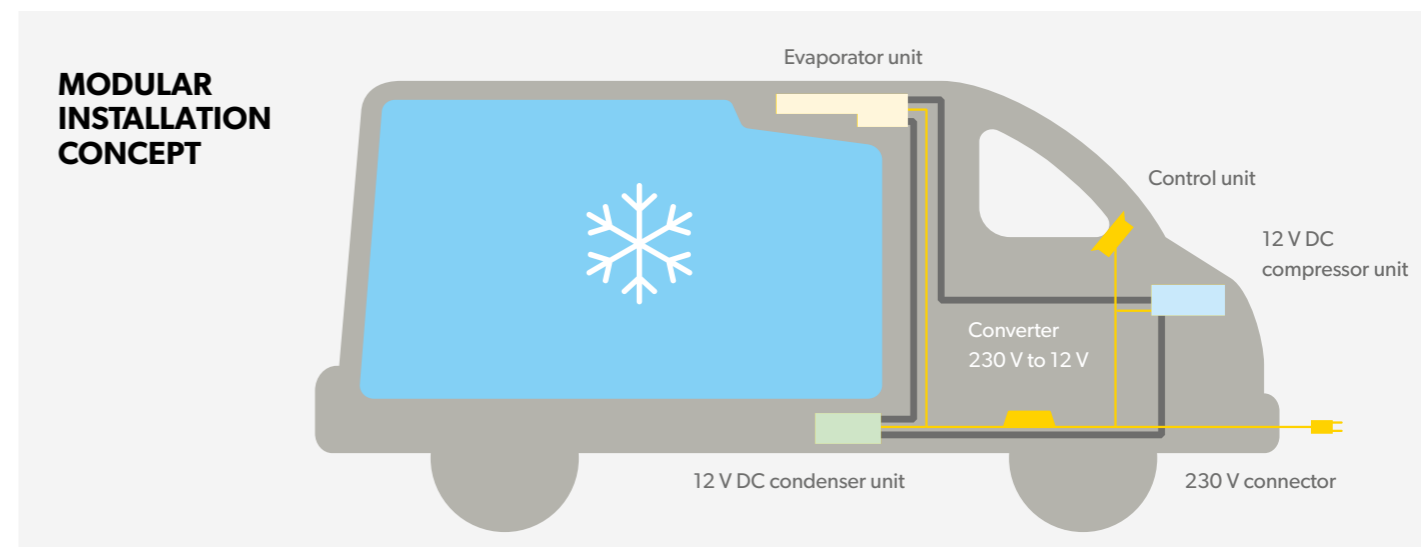

## COMPONENTS CAN BE COMBINED FOR ANY APPLICATION

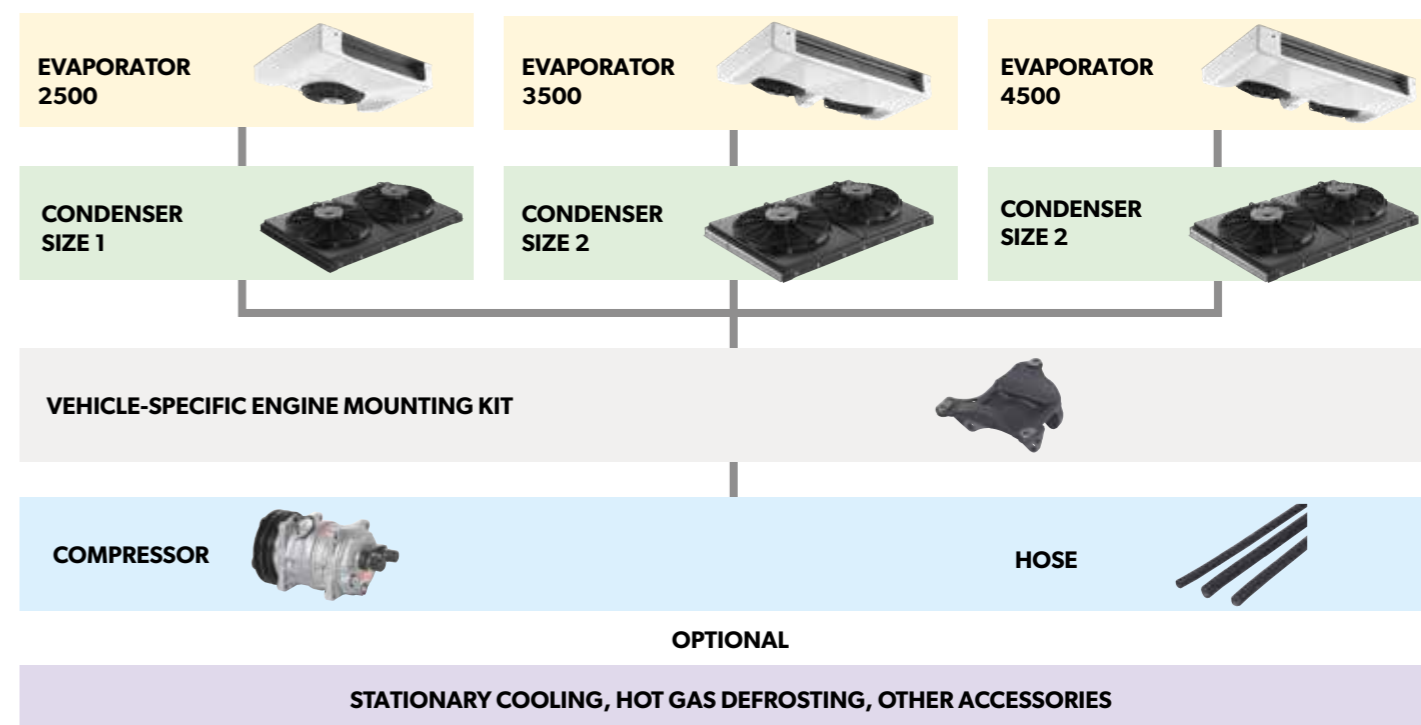







## DOMETIC TL200 / TL300 / TL450

Heavy-duty refrigeration and deep-freeze container with two factory preset fixed temperatures (can be switched)

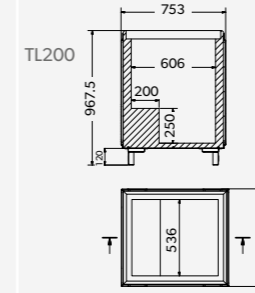
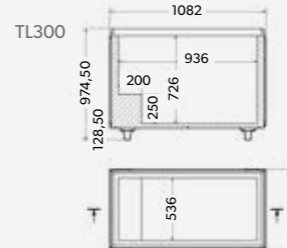
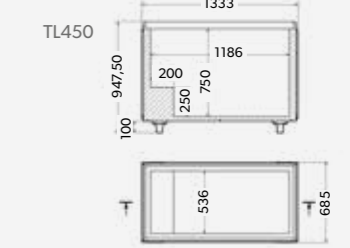
	TL200	TL300	TL450
<b>Capacity</b>	188 l	304 l	393 l
<b>Voltage</b>	12 volts DC and 230 volts AC (24 volts DC on request)		
<b>Power consumption</b>	300 watts		
<b>Temperature range</b>	Fixed temperature +4 °C / -18 °C (at an ambient temperature of max. +38 °C)		
<b>Refrigerant/ amount / CO<sub>2</sub> equivalent/ GWP</b>	R 404a/ 150 g / 0.588 t/ 3922	R 404a/ 160 g / 0.628 t/ 3922	R 404a/ 245 g / 0.961 t/ 3922
<b>Insulation</b>	Polyurethane		
<b>System</b>	DC: Compressor, AC: with built-in power supply		
<b>Material</b>	Sheet steel housing		
<b>Dimensions</b>	967,50 x 753 x 685 mm	974,50 x 1082 x 685 mm	947,50 x 1333 x 685 mm
<b>Weight</b>	110 kg	150 kg	150 kg
<b>Quality features</b>	Heavy-duty design, two fixed temperatures: +4 °C / -18 °C, pallet feet for safe loading and unloading with fork-lifts; attachment points for safe storage on-board; transport rollers as accessories		
<b>Product</b>	<b>Ref. No.</b>		
Dometic TL200	9103540405		
Dometic TL300	9600022114		
Dometic TL450	9103540406		
<b>/ Optional extras see page 197</b>			
 TL200  TL300  TL450			

# PERFECTLY EQUIPPED FOR YOUR LOGISTICS

**CONTROL DOWN TO THE EXACT TEMPERATURE –  
WITH MANY PRACTICAL EXTRAS**

Ice cream vans, on-line produce delivery, fresh goods from wholesalers – these cooler containers from Dometic offer safe, tailor-made, cooling solutions. Available as a front loader or top loader. Easy-to-operate slide doors, pallet feet and transport rollers

(accessories) ensure comfortable handling. The optional battery set (page 197) can retain the set temperature for up to 8 hours without an external power supply.

## DOMETIC FO200 NC / FO450 NC

Heavy-duty refrigeration container with a factory preset fixed temperature

	FO200 NC	FO450 NC
FO200 NC		
		
<b>Capacity</b>	188 l	393 l
<b>Voltage</b>	12 volts DC and 230 volts AC (24 volts DC on request)	
<b>Power consumption</b>	108 watts	
<b>Temperature range</b>	Fixed temperature +4 °C (at an ambient temperature of max. +38 °C)	
<b>Refrigerant/ amount / CO<sub>2</sub> equivalent/ GWP</b>	R 134a/ 150 g/ 0.215 t/ 1430	R 134a/ 195 g/ 0.279 t/ 1430
<b>Insulation</b>	Polyurethane	
<b>System</b>	DC: Compressor, AC: with built-in power supply	
<b>Material</b>	Sheet steel housing	
<b>Dimensions (W x H x D)</b>	802 x 753 x 847,50	782 x 1333 x 847,50
<b>Weight</b>	110 kg	150 kg
<b>Quality features</b>	Heavy-duty design, one fixed temperature: +4 °C, pallet feet for simple and safe loading and unloading with fork-lifts; attachment points for safe stowage on-board; optional battery set for independent power supply; transport rollers available as accessories	
<b>Product</b>	<b>Ref. No.</b>	
Dometic FO200 NC	9103540408	
Dometic FO450 NC	9103540409	
<b>/ Optional extras see page 197</b>		
FO200		FO450
		

## DOMETIC FO800 NC / FO850 NC / FO1000 NC

Heavy-duty refrigeration container with a factory preset fixed temperature

	FO800 NC	FO850 NC	FO1000 NC
FO800 NC			
			
<b>Capacity</b>	605 l	788 l	901 l
<b>Voltage</b>	12 volts DC and 230 volts AC (24 volts DC on request)		
<b>Power consumption</b>	300 watts		
<b>Temperature range</b>	Fixed temperature +4 °C / -18 °C (at an ambient temperature of max. +38 °C)		
<b>Refrigerant/ amount / CO<sub>2</sub> equivalent/ GWP</b>	R 404a/ 175 g/ 0.25 t/ 1430	R 134a/ 175 g/ 0.25 t/ 1430	R 134a/ 175 g/ 0.25 t/ 1430
<b>Insulation</b>	PU foam		
<b>System</b>	Fully hermetic DC compressor and no frost air circulation system		
<b>Material</b>	Fibre glass cabinet with stainless steel frame construction and stainless steel base		
<b>Dimensions (W x H x D)</b>	1100 x 1100 x 1383 mm	807 x 1639 x 1137 mm (1137 with door)	808 x 1760 x 1135 mm (1208 with door)
<b>Weight</b>	121 kg	113 kg	123 kg
<b>Quality features</b>	Innovative no frost air flow concept – reaches also the corners, high-quality fibre glass cabinet with stainless steel frame and stainless steel base, secure closing system – emergency opening from inside possible, suitable for most common van models, approved by leading logistic companies, green status-LED		
<b>Product</b>	<b>Ref. No.</b>		
Dometic FO800 NC	9600002642		
Dometic FO850 NC	9600024343		
Dometic FO1000 NC	9600002641		
<b>/ Optional extras see page 197</b>			
FO800 NC		FO850 NC	FO1000 NC
			



## DOMETIC FO650

Heavy-duty refrigeration container with a factory preset fixed temperature

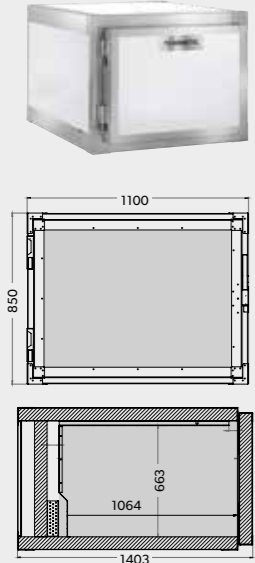
	<b>Capacity</b>	607 l
	<b>Voltage</b>	12 volts DC and 230 volts AC (24 volts DC on request)
	<b>Power consumption</b>	300 watts
	<b>Temperature range</b>	Fixed temperature +4 °C / -18 °C (at an ambient temperature of max. +38 °C)
	<b>Refrigerant/ amount / CO<sub>2</sub> equivalent/ GWP</b>	R 404a/ 210 g/ 0.824 t/ 3922
	<b>Insulation</b>	PU foam
	<b>System</b>	Fully hermetic DC compressor and no frost air circulation system
	<b>Material</b>	Fibre glass cabinet with stainless steel frame construction and stainless steel base
	<b>Dimensions (W x H x D)</b>	1422 x 850 x 1100 mm
	<b>Weight</b>	180 kg
<b>Quality features</b>	Innovative no frost air flow concept – reaches also the corners, high-quality fibre glass cabinet with stainless steel frame and stainless steel base, secure closing system – emergency opening from inside possible, suitable for most common van models, approved by leading logistic companies, green status-LED	
<b>Product</b>	<b>Ref. No.</b>	
Dometic FO650	9600024342	

# OPTIONAL ACCESSORIES FOR REFRIGERATION AND DEEP-FREEZE CONTAINERS

In developing our refrigeration containers, we have taken into account many practical requirements – e.g. equipment for transporting with forklifts. Alternatively, you can replace the pallet feet with wheels. Or add a digital system to document temperature variations.

Choose what fits your application!

REFRIGERATION AND DEEP-FREEZE CONTAINERS	DT-08N THERMAL PRINTER	DT-23 ONE FACTORY PRESET FIXED TEMPERATURE	DT-24 BATTERY SET INCLUDING CHARGER	DT-25 WHEEL SET	DT-31 METAL PALLET	DT-32 24 VOLT DC SET
TL200	•	•*	•*	•		•
TL300	•	•*	•*	•		•
TL450	•	•*	•*	•		•
FO200 NC	•	•*	•*	•		•
FO450 NC	•	•*	•*	•		•
FO650	•	•*		•		•
FO800 NC	•	•*		•		•
FO850 NC	•	•*		•	•	•
FO1000 NC	•	•*		•	•	•

\* only available as original equipment



### DT-07N

Temperature data logger as a single unit, without software. Software download from [www.testo.com](http://www.testo.com)

Ref. No. 9103540007



### DT-23

Configuring a fixed temperature in the range from +4 °C to +25 °C according to customer requirements. Tolerance: ± 2 °C. Automatic heat & cool function. Test report included in the scope of supply.

Ref. No. 9103540428

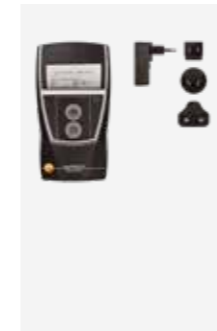

### DT-08N

Thermal printer for displaying the temperature variation graphically (to be used in combination with DT-07N).

Ref. No. 9103540008



### DT-24

Battery set including charger. For off-mains operation for up to 8 hours (at an external temperature of +32 °C). Only available as a factory-fitted option.

Ref. No. 9103540411



### DT-25

Wheel set (4x set) for safe and easy transport to the place of installation

Content: 2 fixed wheels, 2 movable wheels with parking brake, height: 127 mm

Ref. No. 9103540412



### DT-31

4-way metal pallet (Euro size) screwed to the container to increase flexibility in use with a forklift truck. Increased overall height: 130 mm. 1200 x 800 x 130 mm (L x W x H) Load capacity 1500 kg For FO850 NC and FO1000 NC

Ref. No. 9600024929



### DT-32

24 Volt DC set

Extension of reefer containers to 24 volt application.

Ref. No. 9600024930