

BUYING GUIDE

TRUCK PARKING COOLERS

FIND THE RIGHT PARKING COOLER FOR YOUR TRUCK

Mobile living made easy.

 **DOMETIC**

CONTENTS

01

The ideal cabin climate

02

Select the model to suit your truck and your working day

03

A deeper look into the technology and testing procedures

04

Coolair RTX

05

CoolAir RT 780

06

CoolAir SPX 1200

07

Which parking cooler fits which truck?
A brief overview

A familiar picture in parking areas: truck drivers leaving the engine running for hours to use the air conditioner or to recharge the batteries during their resting periods. This is bad for the environment, and it's also against the law. Tons of fuel are wasted, and fleet operators pay

dearly for it, plus the wear and tear on the engine. A parking cooler keeps operating costs down. Equally important to fleet owners is the fact that it improves work safety and thus ensures that the driver and freight arrive safe and sound.



TRUCK PARKING COOLERS

DOMETIC COOLAIR – A CALCULATION THAT
WORKS OUT FINE FOR FLEET OPERATORS

THE IDEAL CABIN CLIMATE

A COMFORTABLE FEELING
IT'S ALL ABOUT TEMPERATURE AND HUMIDITY

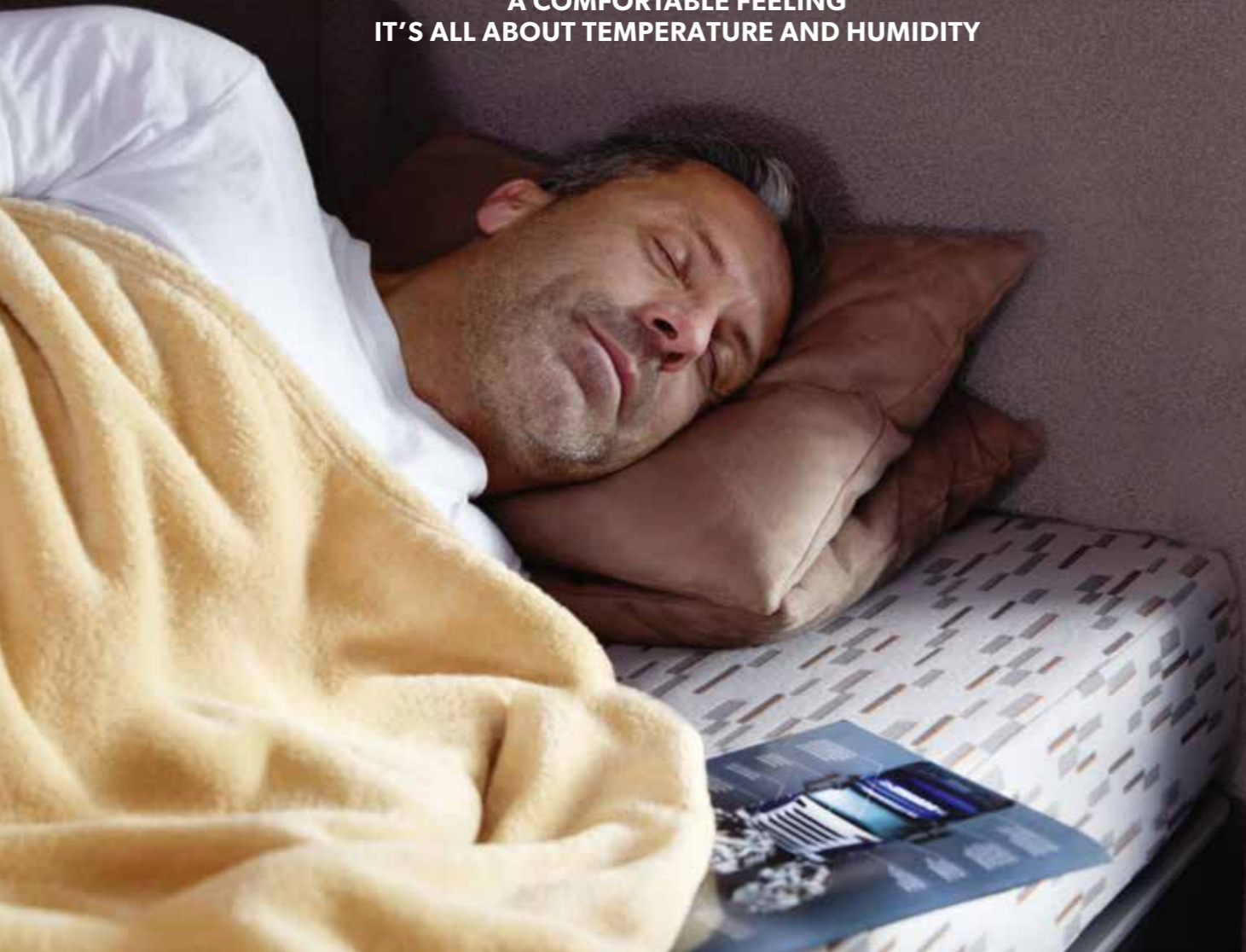

The air temperature felt by the human body may differ from the actual, measured air temperature. Our thermal sensation ranges from warm or hot through comfortable to cold. We all want to enjoy a comfortable climate, and humidity plays a decisive role. When humidity is low, we tolerate even hot air temperatures even though we sweat. Dry heat makes the sweat evaporate quickly from the skin and creates a cooling effect. This won't happen, though, in a warm humid climate, when humidity is high transpiration diminishes and

with it the cooling effect. As a result, we feel the heat even more. The air feels damp and sticky, which may lead to circulatory troubles and insomnia.

Knowing all this, it becomes obvious what a good truck parking cooler ought to do. Cooling alone is not enough; it's also necessary to reduce the humidity to get a comfortable climate.

COMFORTABLE CLIMATE AT 26 °C

The air temperature and humidity range perceived as comfortable

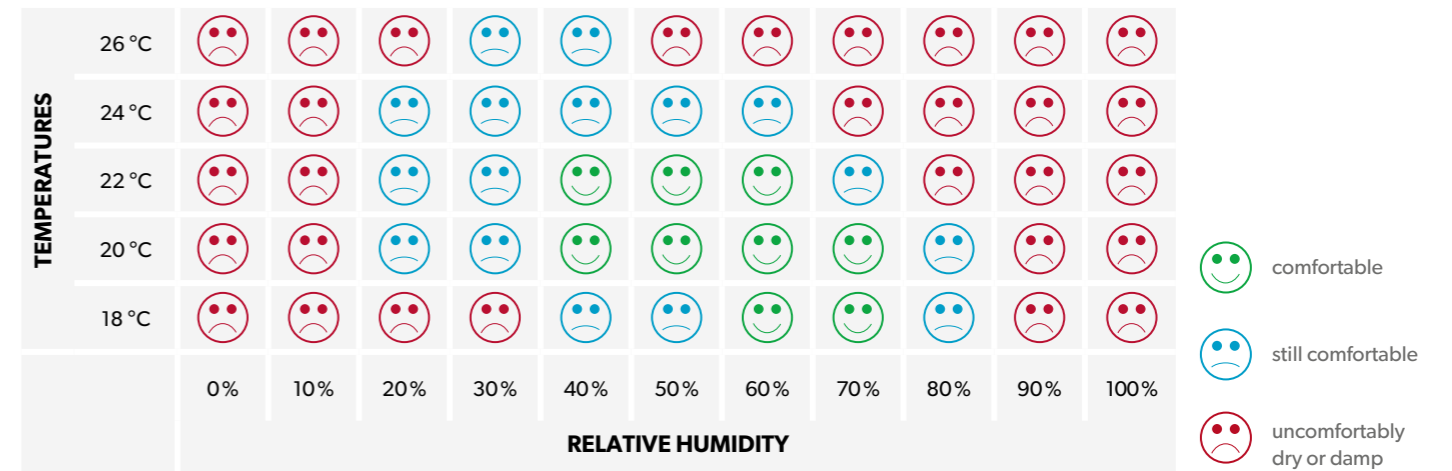

OUR TIP: COMPRESSOR PARKING COOLERS

Compressor-powered parking coolers are the most effective ones. Unlike condenser-operator systems they also reduce the air humidity.



DOMETIC COOLAIR TRUCK PARKING COOLERS

SELECT THE MODEL TO SUIT YOUR TRUCK AND YOUR WORKING DAY

CoolAir compressor parking coolers have been around for over ten years to improve working conditions, safety and cost efficiency in the European utility vehicle industry. Powerful and efficient like no other, they offer unique benefits for drivers, installers and fleet operators. Vehicle-specific mounting accessories available for all common truck models make for fast and easy installation with perfect results.

The current Dometic CoolAir range includes three self-contained rooftop air conditioners integrating all components in a compact housing and a modular split system for tricky installation conditions, such as cabins with spoilers. This buying guide is meant to help you find the right CoolAir model to suit your truck, your working conditions and your idea of a perfect cabin climate.

SELF-CONTAINED PARKING COOLERS FOR INSTALLATION ON THE CABIN ROOF



COOLAIR RTX 1000

Highly efficient truck parking cooler with third generation CoolAir technology. 1200 watts of power, up to 12 hours runtime. Ideal for longer trips in moderate climates.



COOLAIR RTX 2000

Generating a full 2000 watts for up to 6 hours, this power pack cools down even larger cabins in no time at all. Tested and approved in Australia. Perfect for everyone resting at daytime or going to hot regions.



COOLAIR RT 780

This rooftop parking cooler is designed for day trips and inner-city distribution services. It gives drivers a pleasant climate during shorter stops and waiting periods.



SPLIT PARKING COOLER FOR TRICKY INSTALLATION CONDITIONS



COOLAIR SPX 1200

What do you do if there's no way to install a roof parking cooler, because the cabin is too tall or already fitted with a roof-mounted structure, or the roof slope is too high? For cases like these we have designed the SPX 1200 split parking cooler.





CREATE COMFORT

THE TASK OF A TRUCK PARKING COOLER

Relaxed drivers are safer drivers who are less likely to be involved in accidents. This is one of the reasons why the laws on resting periods for truck drivers are so strict. But what are the conditions drivers need to rest in complete comfort?

The temperature range we perceive as comfortable is not really that wide, as the illustration on page 5 shows. Temperatures up to 26 °C are only felt as pleasant when humidity is low. When the air is damp, the thermometer should not exceed 20 °C. We feel more

comfortable when the room temperature is between 18 °C and 22 °C and the humidity between 40 and 70 %.

To create these conditions in a truck cabin the air must be cooled down and dehumidified at the same time. This calls for a compressor powered air conditioner. A/C systems based on direct or indirect evaporation cooling are less effective.



PERFECT CLIMATE IN EVERY SITUATION

The two CoolAir RTX systems give drivers a choice of four operating modes to make it even easier for them to adjust the cooling capacity to individual climate conditions and personal comfort requirements.

- **AUTOMATIC MODE:** Fan and compressor are controlled automatically.
- **ECO MODE:** The compressor speed is limited to a maximum of 2400 revs/min (instead of 3600 revs/min). This saves energy and extends the runtime.
- **BOOST MODE:** Compressor and fan are running at full capacity – for a maximum of 20 minutes, or until the preset temperature has been reached. Then the system switches back to automatic mode.
- **MANUAL MODE:** The blower speed can be set to five different levels.



PERFORMANCE TESTS CONFIRM BEST RATINGS FOR RTX

CoolAir RTX parking coolers keep it nice and cool, even in soaring heat. CoolAir RTX lives up to its promise even at outside temperatures of 52 °C.

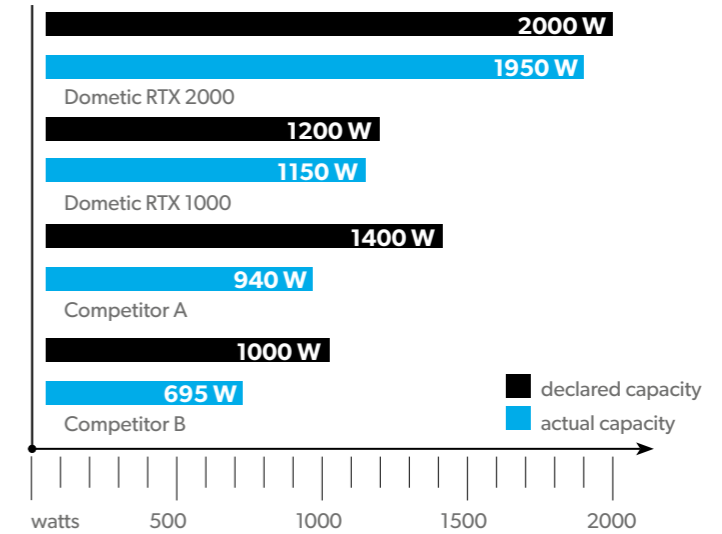

15 GOOD REASONS TO OPT FOR A COOLAIR TRUCK PARKING COOLER

- High pressure cleaner test passed. A vehicle with a CoolAir RTX can be cleaned in a truck washing machine.
- Superior performance: CoolAir air conditioners run longer, quieter and more economical – even at high ambient temperatures up to 52°C
- Reduced fuel consumption: no engine running during resting periods
- Self-explanatory, convenient operation: 4 operating modes (RTX series), individual air flow regulation
- Restful breaks without noise and exhaust gas exposure: concentrated drivers, less accidents
- Contemporary automotive design perfectly matching the vehicle inside and out
- Approved road compatibility: tested and certified by independent test laboratories
- Vehicle-specific installation concept: fast and easy installation, 100% clean removal
- CoolAir freedom of choice: models of different capacity to be selected for specific applications; tailor-made solutions for all common types of trucks
- ADR-compliant: no refitting necessary (CoolAir RTX, CoolAir SPX 1200)
- Worldwide service network: minimal downtimes in case of repairs
- IP-test, DIN 40050-9
- Hot/cold cycle test
- Saltwater spray test
- Field tests in Europe and Australia

GENUINE PERFORMANCE

CoolAir air conditioners run longer, quieter and more economical. The RTX is able to guarantee perfect functionality at every tough condition stipulated. Keep this in mind when comparing their performance with competitors' products!



The CoolAir RTX proofed itself robust in a series of tough tests, e. g. accelerated life testing. Tests have been done on the shaker table as well as in the climatic chamber.

FIELD TEST OF PARKING COOLERS – COOLAIR RTX 1000 HITS ALL RECORDS!

At the end of May 2017 a leading East European transport company tested truck parking coolers of four major brands to support the decision-making for a future investment. During the two-day test run, all candidates – including the CoolAir RTX 1000 – were subjected to real-life conditions for about twelve hours. We are very pleased to let you know that our CoolAir RTX 1000 was the test winner in all categories. It performed even better than promised in our catalogues.

TEST CONDITIONS

- Two three-year-old trucks as testbeds (DAF XF and MB Actros)
- Trucks parked on asphalt and subjected to direct sunlight
- Cabin temperature set to 22 °C
- Battery guard operated at factory default setting
- Day 1: switch-on at 11:15; factory-new battery package; without using the sun shades/curtains
- Day 2: switch-on at 09:30; used but freshly charged battery package; with the sun shades/curtains closed

TEST RESULTS FOR COOLAIR RTX 1000

To cut a long story short, our parking cooler hit all records in the test!

- RTX showed the quickest cool-down in both cabs/on both days.
- RTX was the only unit to reach the setpoint (22 °C) in both cabs (both days)
- RTX was the only unit to keep the lower bed temperature at a comfortable “resting level” through the entire runtime.
- RTX provided the longest runtime while maintaining the required temperature.
- RTX had the highest battery readings at any given moment of the test – i.e. the lowest energy consumption.

RTX 1000
Test winner!



MORE COOLAIR BENEFITS A DEEPER LOOK INTO THE TECHNOLOGY AND TESTING PROCEDURES

LOW MAINTENANCE COSTS

The engines of trucks fitted with a parking cooler require less maintenance. This is simply because drivers are less likely to have them run idle to operate the A/C system in their resting periods. The longer service intervals reduce the maintenance costs for fleet operators.

Speaking of maintenance costs ... self-contained CoolAir air conditioners are virtually maintenance-free. All components are integrated in a compact housing. The A/C circuit is closed and hermetically tight. No need to fill up with refrigerant.

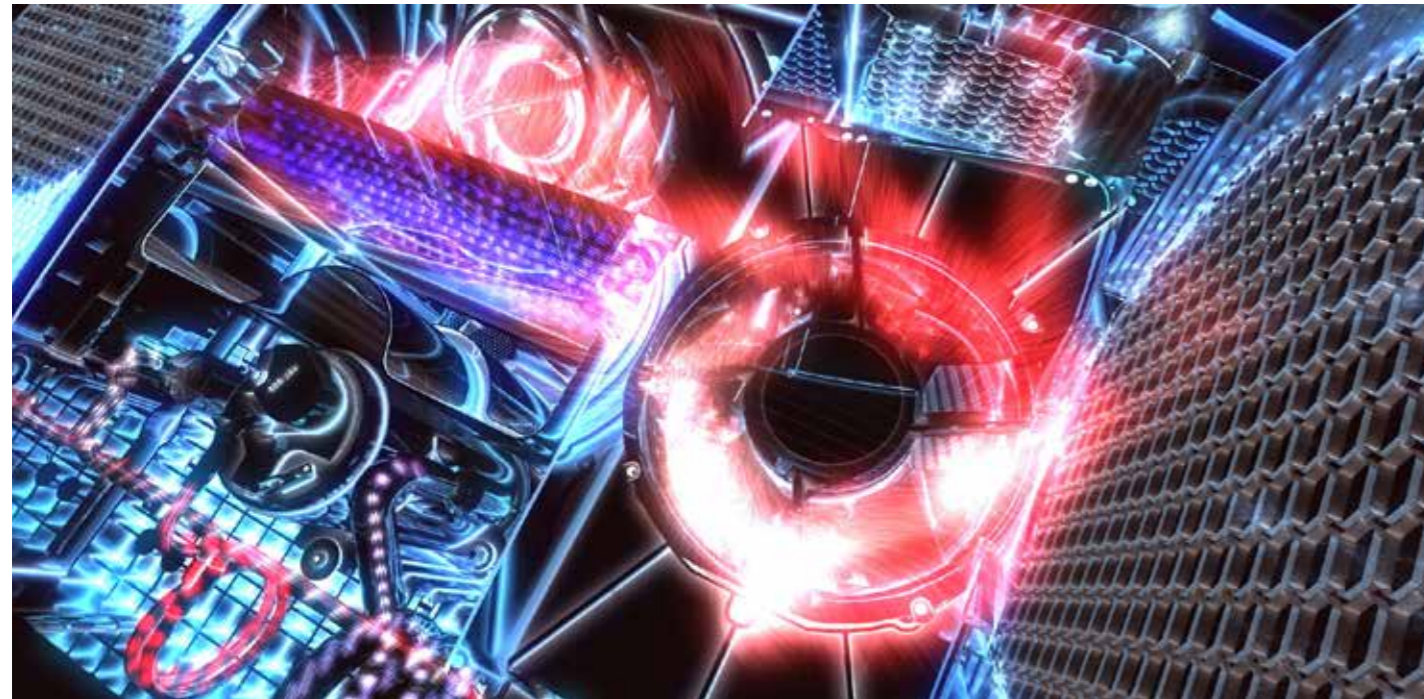

SUPERIOR ENERGY EFFICIENCY

CoolAir RTX parking coolers feature a variable speed inverter compressor, which allows for excellent cooling, amazingly quiet operation and superior energy efficiency.

Moreover, our latest generation parking coolers are fitted with a smart refrigerant injection technology to make more economical use of refrigerant. While other manufacturers use a rather "static" capillary tubing system, the inventors of the CoolAir RTX opted for an adaptive, thermostat controlled expansion valve. The expansion valve ensures that the evaporator always gets the right amount of refrigerant – no more and no less than required to achieve the desired temperature in the driver's cab. Quite similar to the automatic transmission of a car, the CoolAir RTX refrigerant injection system automatically adapts to the performance requirements. Capillary systems, by contrast, always inject the same amount of refrigerant. Using the same metaphor, they are like an engine running full throttle all the time.



ADR-COMPLIANT FOR DANGEROUS GOODS TRANSPORT

The European Agreement Concerning the International Carriage of Dangerous Goods by Road (ADR for short) contains special provisions as to the security of load, the marking of dangerous goods and the equipment of vehicles participating in road transport.

The two CoolAir RTX parking coolers and our CoolAir SPX 1200 split system are ADR-compliant. That means they can be installed and operated with no further refitting and no special entry in the vehicle documents required.



COOLAIR RTX ... STAY COOL FOR LONGER



Operates up to
52 °C ambient
temperature



HERE'S WHAT COOLAIR RTX CAN DO FOR TRUCK DRIVERS:



- Operates up to 52 °C ambient temperature
- Significantly longer running time
- Very quiet operation
- Accurate temperature control
- Self-explanatory, convenient operation
- 4 operating modes, individually adjustable air distribution
- Peaceful resting periods without noise or exhaust gas exposure
- Contemporary automotive design
- Choice of capacity versions to suit the application
- Battery status monitoring via separate line

COOLAIR RTX ... CUTS OPERATING COSTS

HERE'S WHAT THE NEW COOLAIR GENERATION DOES FOR FLEET OPERATORS:

A CoolAir RTX truck parking cooler keeps operating costs down. Especially so if it has such an amazingly long running time like the CoolAir RTX 1000. Our sample calculation shows how much money can be saved if the engine is not running during resting periods to keep the cabin cool. And the protection against wear and tear of the engine is not taken into account ...

Fleet operators also appreciate the benefits in terms of road safety. Resting periods in a quiet and pleasantly cool cabin let drivers continue the journey with full concentration and avoid accidents. Last but not least, fitting a truck with a parking cooler helps find qualified employees and keep them loyal to the company.



REDUCED FUEL CONSUMPTION

Engine is not running during the resting periods

Sample calculation

Diesel price	1.19 €
Truck running idle:	Ø 6 h/day
Average usage per year:	100 days
Fuel consumption per hour (when running idle) approx.	3 – 4 l/h

Fuel savings

100 days x 6 hours x 3.5 l/h x 1.19 €/l	2,499.00 €
---	------------

COOLAIR RTX PARKING COOLERS FOR TRUCKS

THE BEST COOLAIR WE'VE EVER MADE

CoolAir compressor parking coolers have been around for over ten years to improve working conditions, safety and cost efficiency in the European utility vehicle industry. The CoolAir RTX series comes with an entirely new technology to continue a unique success story. Powerful and efficient like no other, it offers unique benefits for drivers, installers and fleet operators.



VERY QUIET RUNNING

4 OPERATING MODES
(AUTO, ECO, MANUAL, BOOST)

HIGHLY EFFICIENT,
LOW POWER CONSUMPTION

COOLAIR RTX – STAY COOL FOR LONGER

More efficiency, more power – this, in essence, is what the third generation of our CoolAir parking coolers is all about. It comes in two capacity versions to cater for different demands. CoolAir RTX 1000 provides more cooling performance and a longer running time while consuming less energy than its predecessor model. CoolAir RTX 2000

generates more than twice the cooling power at the same running time. All of this is possible thanks to the use of a variable speed inverter compressor, which makes for excellent cooling performance and amazingly efficient and quiet operation.

HERE'S WHY INSTALLERS CHOOSE COOLAIR RTX:

- CoolAir installation concept: fast and easy installation – 100 % clean removal when the vehicle-specific installation kits are used
- Modular CoolAir assembly kits
- Elegant design: all CoolAir systems perfectly match the vehicle, inside and out





DOMETIC COOLAIR RTX 1000

Truck roof parking cooler, 24-volt stationary air conditioning

- 1200 watts cooling capacity
- Up to 12 hours runtime at full cooling capacity
- **At 30 °C ambient temperature only 8 A current consumption in ECO mode**
- Very quiet running
- 4 operating modes (Auto, Eco, Manual, Boost)
- Ideal for longer trips in moderate climates
- Operates up to 52 °C ambient temperature



DOMETIC COOLAIR RTX 2000

Truck roof parking cooler, 24-volt stationary air conditioning

- 2000 watts cooling capacity
- Up to 6 hours runtime at full cooling capacity
- **At 30 °C ambient temperature only 9.5 A current consumption in ECO mode**
- Very quiet running
- 4 operating modes (Auto, Eco, Manual, Boost)
- Ideal for hot climates and for use during the day
- Operates up to 52 °C ambient temperature
- Suitable for all kinds of roof pitches

Have you opted for CoolAir RTX? Then don't forget to add the matching vehicle-specific installation kit to your order! It includes everything required for installation on the vehicle you have – from the

cover frame to the connection cable – and is available for all common types of trucks. For other or older-make utility vehicles with or without a roof hatch, two universal installation kits are on offer.

VEHICLE-SPECIFIC INSTALLATION CONCEPT

ROOF UNIT

Prepared for specific vehicles for ease of installation



INSTALLATION FRAMES

Vehicle-specific installation frame, harmoniously integrated to match the design and colour of the cabin ceiling

REMOTE CONTROL

ON/OFF

Temperature set buttons

Operation mode buttons

A, E, B
Auto, Eco, Boost mode direct selection

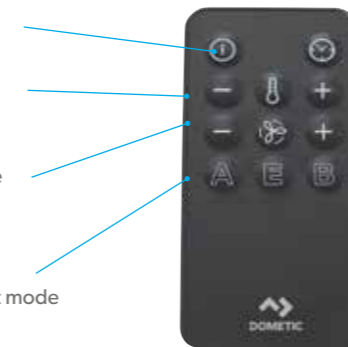

CONTROL PANEL: FUNCTIONAL AND EASY TO USE



- 1 ON/OFF switch
- 2 Menu
- 3 Select button (up)
- 4 Select button (down)
- 5 Blue LED: system running
- 6 Status readout



COOLAIR RTX
BUYING GUIDE TRUCK PARKING COOLERS

2.09 / Dometic CoolAir

TECHNICAL DATA	COOLAIR RTX 1000	COOLAIR RTX 2000
ROOF PARKING COOLERS		
Ref. No.	9105306744	9105306745
Voltage (volts DC)	24	24
Current consumption (A)	5 – 25	5 – 29
Cooling capacity (W)	1200	2000
Contains fluorinated greenhouse gases. Hermetically sealed equipment.	R 134a / 0.35 kg CO ₂ -Equivalent = 0.500 t	R 134a / 0.8 kg CO ₂ -Equivalent = 1.144 t
System	Self-contained and battery operated truck parking cooler to be installed in the existing roof hatch. Hermetically sealed and maintenance free refrigerant circuit with inverter compressor. Adjustable low-voltage cut-out.	
Dimensions (W x H x D)	860 x 308 x 643 (height on roof: 169 mm – without gasket)	
Weight (kg)	approx. 22.8	approx. 31.5
Colour / Material	Top cover: ASA/PC, white, Base: ASA/PC, anthracite	
Quality features	Latest generation inverter compressor technology, low-voltage cut-out with sensing line, remote control, multi-line display	
Test marks	e-approved (Automotive EMC Directive)	
Scope of delivery	Parking cooler, remote control, operating manual	
/ Accessories (optional)		
Battery connection cable, 6 mm ² , 11 m long, for vehicles with power management	9100300108	9100300108
Set for electrical circuit protection when the 11 m cable is used	9100300110	9100300110



/ Accessories (required)

Vehicle-specific installation kits RTX 1000 / RTX 2000
 (covering frames, seals, fixing materials, connection cable, installation instructions)

Vehicle	Ref. No.
DAF XF 106, SC	9100300078
DAF XF 106, SSC ⁶	9100300079
Iveco Stralis HI-STREET, HI-ROAD	9100300087 (RTX 2000 only)
Iveco Stralis HI-WAY	9100300088 (RTX 2000 only)
MAN TGS/TGX XL, XXL, LX ¹	9100300080
MAN TGS/TGX XL, XXL, LX, LION BEIGE 2017	9100300128
MB Atego ^{1,3}	9100300081
MB Actros, Antos, Arocs (SFTP) ^{1,5}	9100300082
Renault T + C, H1	9100300089
Renault T + C, H2 ⁴	9100300090
Scania S NEW Model 2016 >	9100300132
Scania Topline, Highline ²	9100300083
Universal 1 (screw fastening)	9100300085
Universal 2 (bracket fastening)	9100300086

All installation kits are designed for current vehicle models. More models on request. Please check "preconditions for installation" document for further installation information.
Scope of delivery: cover frame, seals, installation fittings, 4 m connection cable incl. sensing line, installation instructions

¹ MAN and MB kits with 11 m connection cable and matching installation material

² For mechanical roof hatch you will additionally require 2 original Scania brackets (Scania item number 1533737) for installation.

³ Only for electrical roof hatch, for manual roof hatch use Universal 1

⁴ For Trucks with air deflector, check with Renault for installation options / not for High-Sleeper Cap

⁵ Not for Compact and GigaSpace roof versions

⁶ Check total height of truck, in some configurations (chassis, tyres) the total height including RTX may exceed allowed 4 m.

STAYS COOL FOR LONGER!

It took only a few modifications from the Rally Team to make the RTX fit for the extremely tough and dusty racing track. Good to know that the parking cooler has also passed the high pressure cleaner test!



COOLAIR RTX 2000 AT THE RALLY DAKAR THUMBS UP FROM THE BIG SHOCK RACING TEAM

January 20, 2018 saw the end of the 40th edition of the Rally Dakar in Córdoba. This time the world's most famous racing spectacle took the participants from the deserts of Peru through the high plateaus of Bolivia into the back country of Argentina. 525 drivers from 54 countries joined the almost 9000 kilometre long marathon race struggling their way through gravel tracks, desert sand and narrow gorges. Martin Macík, 28-year-old racing pilot from Czechia, and his two companions from the Big Shock Racing Team scored an excellent fifth place finish in the truck competition. Also lining up at the start gate was the CoolAir RTX 2000 from Dometic. It took over the job of the vehicle air conditioning system, which had been removed to reduce the overall weight. And the RTX did what it was expected to do: it cooled and cooled and cooled! "No problems whatsoever," was the feedback of racing pilot Martin Macík. After some minor reworking the Big Shock Racing Team's technicians had done after the experience in preceding competitions, everything had been just fine. "The only thing we had to do was to shut the cooler off at a crossing, because we were all cold in the cabin despite the heat outside," recalls Macík.

Here's some background information: In October 2016, the CoolAir RTX 2000 was installed, for the first time, in the LIAZ truck of Martin Macík and his Big Shock Racing Team. The RTX was then used in five racing competitions: Dakar Rally 2017, Baja Poland 2017, Hungarian Baja 2017, Baja Aragon 2017, and El Chott Rally in Tunisia. Managing Director Libor Harvánek: "We checked and tested the RTX after each rally, and we didn't find any technical problem." The only thing they had to do was a minor improvement on the condensation drainage after the Dakar Rally in 2017. Since then everything had been OK.

Harvánek's final feedback statement: "The RTX parking cooler seems to be, in our opinion, an excellent product. It is extremely powerful, also in rally conditions."

"AN EXCELLENT PRODUCT. IT IS EXTREMELY POWERFUL, ALSO IN RALLY CONDITIONS."

Libor Harvánek

Operates up to 52°C ambient temperature



DOMETIC COOLAIR RT 780 TRUCK PARKING COOLER FOR ROOF TOP INSTALLATION

The Dometic CoolAir RT 780 rooftop parking cooler is designed for day trips and inner-city distribution services. It gives drivers a pleasant climate during shorter stops and unavoidable waiting periods, e.g. when loading and unloading. As a self-contained air conditioner, the CoolAir RT 780 integrates all components in a single housing. Installation is quickly done, and there's no need for maintenance either.

Good to know: the CoolAir RT 780 fits almost every truck. It comes in two versions, with 0° or 12° compressor tilt, to accommodate different roof designs. Tailor-made installation kits are available for all common truck models.



DOMETIC COOLAIR RT 780

Truck parking cooler for roof top installation

- Cooling capacity: 820 watts
- Self-contained air conditioner – all A/C components integrated in one roof unit
- Fitted on the roof (air conditioner replaces roof window)
- Suitable for nearly all vehicle models!
- ADR-compliant (certificate upon request). No refitting needed!
- 100 % clean removal when vehicle-specific installation kits are used

CONTROL PANEL: FUNCTIONAL AND EASY TO USE



- 1 On/off switch
- 2 LED red: error indicator
- 3 LED blue: unit in operation
- 4 LED yellow: compressor ON
- 5 Operation mode setting
- 6 Digital status display
- 7 Temperature set buttons

REMOTE CONTROL

ON/OFF

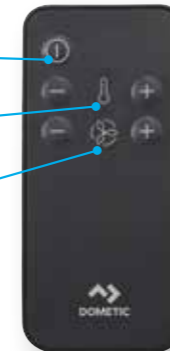

Temperature set buttons

Operation mode buttons



COOLAIR RT 780
BUYING GUIDE TRUCK PARKING COOLERS

2.09 / Dometic CoolAir

TECHNICAL DATA		
ROOF PARKING COOLERS	COOLAIR RT 780	COOLAIR RT 780
Ref. No.	9105306291 (0° compressor tilt)	9105306292 (12° compressor tilt)
Voltage (volts DC)	24	24
Current consumption (A)	12 – 22	12 – 22
Cooling capacity (W)	820	820
Contains fluorinated greenhouse gases. Hermetically sealed equipment.	R 134a / 0.2 kg CO ₂ -Equivalent = 0.286 t	R 134a / 0.2 kg CO ₂ -Equivalent = 0.286 t
System	Self-contained and battery operated truck parking cooler to be installed in the existing roof hatch. Hermetically sealed and maintenance free refrigerant circuit with rotary compressor. Adjustable low-voltage cut-out.	
Dimensions (W x H x D)	830 x 285 x 629 (building height 160 mm)	830 x 285 x 629 (building height 160 mm)
Weight (kg)	approx. 21	approx. 21
Colour / Material	Upper shell white	Upper shell white
Quality features	UV-resistant, paintable upper shell, control panel with digital status readout, four individually adjustable nozzles, cooling and air dehumidification	
Test marks	E-approved (Automotive EMC Directive)	
Scope of delivery	Parking cooler, remote control, operating manual	
/ Accessories (optional)		
Battery connection cable, 6 mm ² , 11 m long, for vehicles with power management	9100300027	9100300027
Remote control	9100300113	9100300113

/ Accessories (required)

Vehicle-specific installation kits
 (covering frames, seals, fixing materials, connection cable, installation instructions)

Vehicle	CoolAir RT 780 (0° compressor tilt)	CoolAir RT 780 (12° compressor tilt)
	Ref. No.	Ref. No.
DAF XF105, XF106, SC	9100300029	–
DAF XF105, XF106, SSC	9100300030	–
IVECO HI-STREET, HI-ROAD ³	–	9100300064
IVECO HI-WAY ³	–	9100300065
MAN TGS/TGX XL, XXL, LX ³	9100300031	–
MAN TGS/TGX XL, XXL, LX LION BEIGE 2017	9100300130	–
MB Actros –2011 ^{1,3}	9100300032	–
MB Actros SFTP/ Antos /Arocs (SFTP) ³ (except Compact Space)	9100300057	–
MB Atego/Axor ³	9100300033	–
Renault T+C, H1	9100300066	–
Renault T+C, H2 (exc. High Sleeper Cab)	9100300067	–
Renault Magnum	9100300034	–
Renault Premium	9100300035	–
Scania S NEW Model 2016 >	9100300131	–
Scania Topline ² / Highline	9100300036	–
Volvo (FH3) L2H2	9100300043	–
Volvo (FH3) L2H3	9100300037	–
Universal 1 (screw mounting)	9100300038	–
Universal 2 (bracket mounting)	9100300039	–

¹ For electrical roof hatch only, for mechanical roof hatch use Universal 1

² For mechanical roof hatches you require 2 original Scania holders (Scania no. 1533737)

³ Incl. battery connection cable 11 m and mounting material

Please note the applicable preconditions for installation (at dometic.com) and the specifications of the vehicle manufacturer

DOMETIC COOLAIR SPX 1200

NEW GENERATION SPLIT PARKING COOLER

The Dometic SPX 1200C compressor unit is the core component of our new generation split parking cooler. Featuring advanced inverter compressor technology, it provides an outstanding cooling capacity of 1200 W (rated to ISO 5151) and two hours of uninterrupted cooling – even at temperatures as high as 52 °C. Thanks to a smart low-voltage protection system, it makes economical use of limited battery power. Depending on the truck cabin and application conditions, you can combine the compressor unit with an evaporator fitted to the inside of the cabin (Dometic SPX 1200I), or with the super-flat rooftop evaporator unit, Dometic SPX 1200T (57 mm). This will keep the total cabin height under 4 m.



SPX 1200C



SPX 1200T



SPX 1200I



**1,200 W POWERFUL
PERFORMANCE**

**SUPER-FLAT ROOF UNIT
ONLY 57 MM**

**UP TO 12 HOURS
RUNTIME**

COOLAIR SPX 1200 THE ALTERNATIVE TO A ROOFTOP PARKING COOLER

What do you do if it is impossible to install a roof parking cooler, because the cabin is too tall or already fitted with a roof-mounted structure, or the roof slope is too high? This is where the CoolAir SPX 1200 split parking cooler comes in. With this system the

compressor unit and the evaporator unit are fitted separately: the compressor unit always to the outside of the cabin wall, the evaporator unit on the roof or to the inner side of the cabin rear wall, depending on the type of cabin you have.

Compressor unit
SPX 1200C



Roof evaporator unit
SPX 1200T

OR



Interior evaporator unit
SPX 1200I

THE BENEFITS OF A DOMETIC PARKING COOLER

Dometic CoolAir parking coolers keep operating costs down. Equally important to fleet owners is the fact that they improve work safety and thus ensure that the driver and freight arrive safe and sound.

- Boost mode for fast chill-down
- Pre-filled with refrigerant for fast installation
- High cooling capacity: 1200 W according to ISO 5151
- 5 A current consumption in Eco mode
- ADR-compliant for all vehicle classes except EX/II, EX/III
- IR remote control
- Vehicle-specific installation kits
- Top cover can be painted
- Low-voltage protection
- Technology tested under extreme conditions in Dakar



COOLAIR SPX 1200 THE CLEVER CHOICE

What do you do if there's no way to install a roof parking cooler, because the cabin is too tall or already fitted with a roof-mounted structure, or the roof slope is too high? Then a version of the CoolAir SPX 1200 split parking cooler will save the situation. With this system

the compressor unit and the evaporator unit are fitted separately: the compressor unit always to the outside of the cabin rear wall, the evaporator unit on the roof or to the inner side of the cabin rear wall, depending on the type of vehicle you have.



SPOILER ALARM!

Roof spoilers fitted in the factory are original parts of the vehicle manufacturer. Their construction has been approved, and it is normally not allowed to modify the design or make any cut-outs. Installing a standard rooftop air conditioner is out of the question in most cases. This is where our modular CoolAir split system offers two smart alternatives.

1 You can use the SPX 1200T configuration with the super-flat roof evaporator unit, which fits neatly under the spoiler.

2 You can opt for the SPX 1200I version and install the evaporator on the inside of the cabin wall, so there's no need for a roof-mounted structure

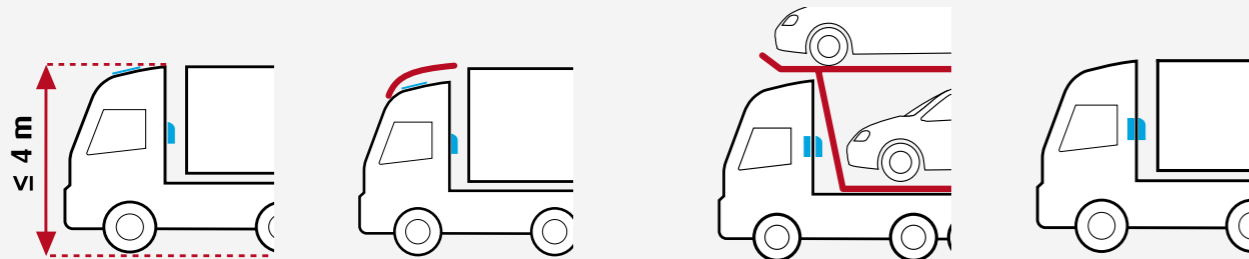

MODULAR SYSTEM CONCEPT: SUPER-FLAT ROOF UNIT OR NOTHING ON THE ROOF

Simply choose which split air conditioner suits you best. The CoolAir assembly kit gives you the option to combine the Dometic CoolAir SPX 1200C compressor unit with two different evaporator units.

For the CoolAir SPX 1200I the evaporator unit is fitted on the inside of the cabin's rear wall, for the CoolAir SPX 1200T it's inside a super-flat roof unit.



DOMETIC COOLAIR SPX 1200T

Truck split parking cooler, 24-volt stationary air conditioning

- Cooling capacity: 1200 watts
- Space-saving installation under spoilers or roof-mounted structures
- 100% clean removal when vehicle-specific installation kits are used
- Up to 12 h runtime without the engine running
- Super-flat with an installed height of 57 mm
- Pre-filled with refrigerant for fast installation



DOMETIC COOLAIR SPX 1200I

Truck split parking cooler, 24-volt stationary air conditioning

- Cooling capacity: 1200 watts
- For installation on the inside of the cabin rear wall
- Up to 12 h runtime without the engine running
- Pre-filled with refrigerant for fast installation

2.09 / Dometic CoolAir

TECHNICAL DATA	COOLAIR SPX 1200T	COOLAIR SPX 1200C	COOLAIR SPX 1200I
SPLIT PARKING COOLERS	COOLAIR SPX 1200T	COOLAIR SPX 1200C	COOLAIR SPX 1200I
	Roof evaporator unit	Compressor unit	Interior evaporator unit
Ref. No.	9600011575	9600011574	9600011576
Voltage (volts DC)	24	24	24
Current consumption (A)	5–25	5–25	5–25
Cooling capacity (W)	1200	1200	1200
Contains fluorinated greenhouse gases. Hermetically sealed equipment.	R134a/0.1 kg CO ₂ -Equivalent = 0.100 t	R134a/0.45 kg CO ₂ -Equivalent = 0.172 t	R134a/0.1 kg CO ₂ -Equivalent = 0.086 t
System	Three blower levels and automatic mode	Rotary compressor for mobile use, soft-start electronics, adjustable low-voltage protection for vehicle battery	Three blower levels and automatic mode
Dimensions (W x H x D)	781 x 168 x 612 mm Height on roof: 57 mm without gasket	367 x 573 x 162 mm	278 x 648 x 147 mm
Weight (kg)	approx. 21	approx. 13	approx. 15
Colour	exterior cover white inside anthracite	white	anthracite
Quality features	UV-resistant upper shell, can be spray-painted, control panel with digital status readout, remote control, five individually adjustable nozzles	UV-resistant upper shell	Control panel with digital status readout, remote control, five individually adjustable nozzles
Test marks	e-approved (Automotive EMC Directive)	e-approved (Automotive EMC Directive)	e-approved (Automotive EMC Directive)
Scope of delivery	Roof evaporator unit, remote control, operating manual	Compressor unit, installation fittings, installation instructions	Interior evaporator unit, exterior supply line cover, remote control, operating manual, fixing material, installation instructions
/ Accessories (optional)			
Battery connection cable, 8 mm ² , 11 m long, for vehicles with power management	9100300027	–	–

VEHICLE-SPECIFIC SPX 1200 INSTALLATION KITS

During the installation of the SPX 1200C compressor unit existing fastening points are used. In our case the mounting holes and bolts on the outside rear of the cabin. The fastening frame for the compressor unit perfectly matches the fastening pattern of the respective vehicle. Besides time savings the CoolAir installation concepts offers two other convincing advantages. The installation result is impeccable, inside and out, like with an original fitting. After removal the CoolAir leaves no mark. No laborious refinishing, no money lost when the vehicle is sold!

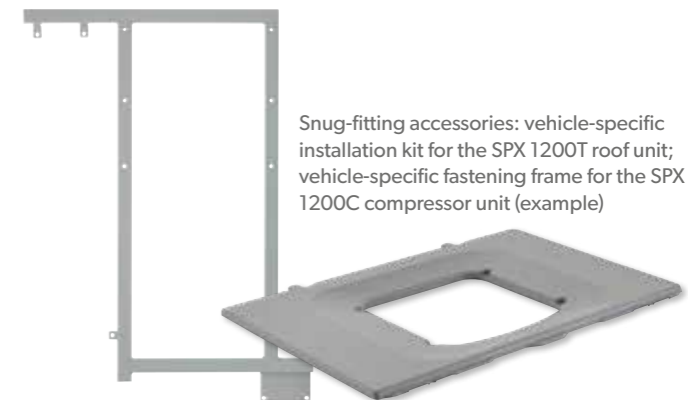

Vehicle-specific installation kits for SPX 1200T (required)

Vehicle	Ref. No.
MAN TGS/TGX XL, XXL, LX ¹	9100300133
MAN TGS/TGX XL, XXL, LX Lion Beige 2017	9100300134
MAN TGX XLX	9100300142
MAN TGX XLX BEIGE	9100300143
Renault T+C, H1	9100300135
Renault T+C, H2, High Sleeper	9100300136
MB Actros/Antos/Arocs (SFTP) ^{1,2,5}	9100300137
SCANIA NG 2017	9100300156
SCANIA Highline/Topline ³	9100300154
DAF XF 106 SSC	9100300138
Iveco Stralis Hi-Way	9100300140
Iveco Stralis HI-STREET, HI-ROAD	9100300141
Universal 1 (screw fastening)	9100300151
Universal 2 (bracket fastening)	9100300152

Vehicle-specific fastening frames for SPX 1200C (required)

Vehicle	Ref. No.
MAN TGS/TGX XXL, XLX	9100300050
MAN TGS/TGX L, LX, XL	9100300049
Renault T+C	9100300071
MB Actros (SFTP)	9100300060
SCANIA NG 2017	9100300155
SCANIA Highline/Topline	9100300054
Volvo FH4 ⁴	9100300072
Iveco Hi-Way Stralis, Hi-Way Euro 6	9100300075
DAF 95/105 + 106 Space /Superspace	9100300046

All installation kits are designed for current vehicle models. More models on request. Please check "Preconditions for installation" document for further installation information.

Scope of delivery: cover frame, seals, installation fittings, 4 m connection cable, installation instructions

¹ MAN and MB kits with 11 m connection cable and matching installation material

² Only for electrical roof hatch (for mechanical roof hatch use Universal 1)

³ For mechanical roof hatch you will additionally require 2 original Scania brackets (Scania item number 1533737) for installation.

⁴ For cabs up to model year 2014

⁵ Not for CompactSpace roof versions

WHICH PARKING COOLER FITS WHICH TRUCK?

Roof parking coolers, 24-volt stationary air conditioning, can be used when your truck has a roof hatch which you can exchange for a parking cooler.



Split parking coolers, 24-volt stationary air conditioning, can be used when the roof hatch is designated as an emergency exit, when the cabin is very high or when there is something mounted over the roof.

COOLAIR RT 780 0° compressor tilt

COOLAIR RT 780 12° compressor tilt

COOLAIR RTX 1000 0° compressor tilt

COOLAIR RTX 2000

COOLAIR SPX 1200C + T Roof evaporator

COOLAIR SPX 1200C + I Interior evaporator

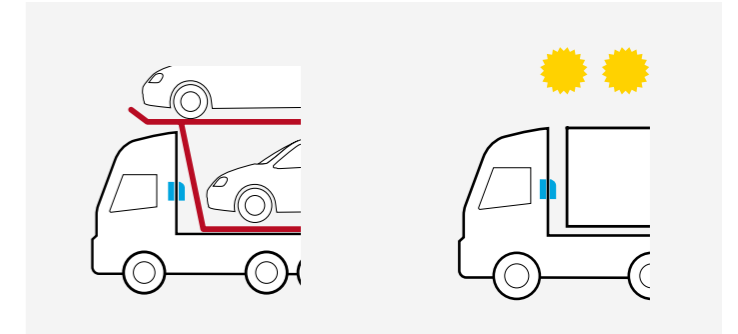
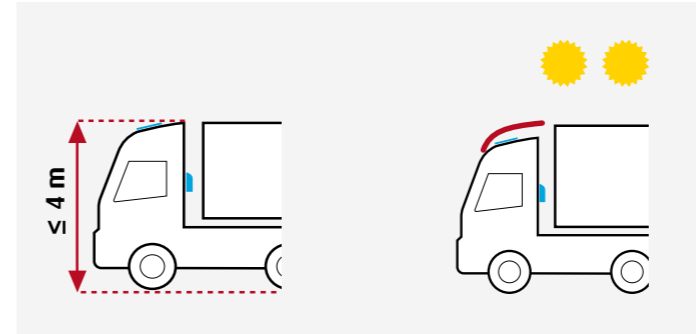
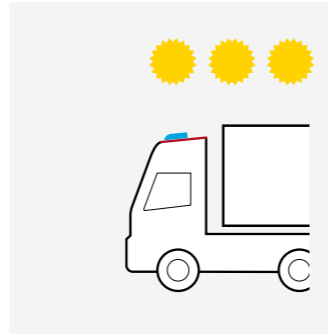
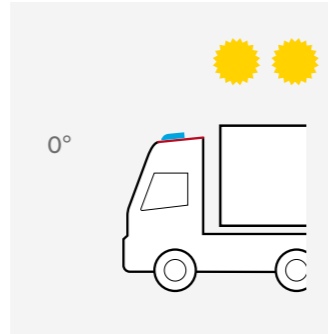
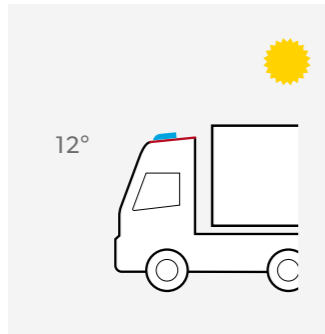
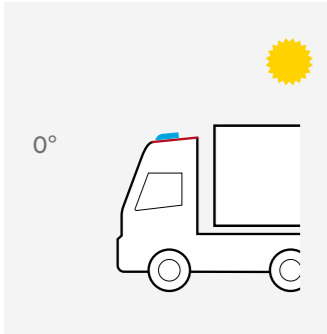

For smaller truck cabins, to be used while waiting periods and lunch breaks at daily trips and inner-city distribution. Please choose the right type for your type of cabin (0° or 12° compressor tilt). Recommendation: up to approx. 3 – 4 hours runtime/day.

For daily and multiday trips with overnight stay. Also recommended for driver's break time during the day in moderate climates. Very long runtime: up to 12 hours.

For daily and multiday trips with overnight stay even in a hot climate. Very high cooling capacity: 2000 watts and up to 6 hours runtime. Also recommended for crew-cabs and up to 12° roof pitch.

For trucks with tall cabins, with roof air deflector or with roof-mounted structures (e.g. car transporters). Super-flat roof evaporator unit – no problems adhering to the maximum permissible height.

For trucks where a roof set-up is not possible or not desirable (large roof slope, tall cabins, with roof spoiler or with roof-mounted structures, roof window should remain). No problems adhering to the maximum permissible height.

THE FULL COMFORT RANGE

View Products:
dometic.com

DOMETIC GERMANY GMBH

Hollefeldstrasse 63

D-48282 Emsdetten

Tel +49 (0) 2572 879-0

Fax +49 (0) 2572 879 -300

Mail info@dometic-waeco.de

Information line for dealers

Tel +49 (0) 2572 879-199

Fax +49 (0) 2572 879-390

Mail vba@dometic.com

Information line for customers

Tel +49 (0) 2572 879-195

Fax +49 (0) 2572 879-322

Mail ev@dometic-waeco.de

